

# Operating Instructions

# MODEL "WM"

## WASHING MACHINE MOTOR

### Adjustment and Repair Information

### Parts List

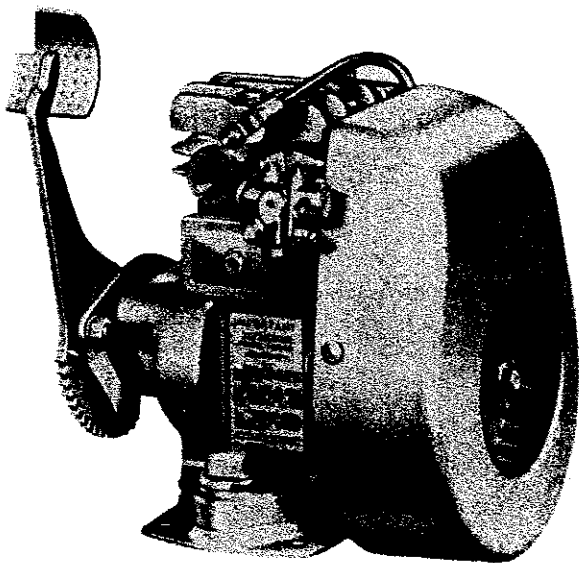

### INDEX

	Page
Starting the "WM" Motor.....	3
Servicing Reference Chart.....	4
Instructions for Adjustment and Repair.....	4
Repair Parts.....	10
Parts List.....	11-13
Guarantee.....	13
Illustrated Parts.....	14
Nation-Wide Service Organization.....	15
Authorized Central Service Distributors.....	15

**Read these instructions carefully before operating this Motor for the first time.**

Guessing how to run it may cause you unnecessary inconvenience, aggravation or failure to receive the fine service that is built into it.

**There is a right way to operate the "WM" Motor. This book tells you how.**

Each Briggs & Stratton Motor is carefully tested and adjusted at the factory before packed for shipment, and if correctly operated will perform beyond your expectations.

**DO NOT START THIS MOTOR UNTIL YOU HAVE READ CAREFULLY "STARTING AND OPERATING THE MODEL "WM" MOTOR" ON PAGE 3**

**4**  
CYCLE

**BRIGGS & STRATTON**

MILWAUKEE, WIS., U.S.A.

GASOLINE  
MOTOR



# IMPORTANT SAFETY INFORMATION AND INSTRUCTIONS FOR ENGINE SELECTION ENGINE INSTALLATION ENGINE OPERATION

In the USA and Canada,  
our 24 hour hotline is:

18002333723

Briggs & Stratton Corporation  
Milwaukee, Wisconsin 53201

[www.briggsandstratton.com](http://www.briggsandstratton.com)

Keep these instructions for future reference.





**Before installing and operating this engine read and observe all warnings, cautions and instructions on both sides of this sheet, on the engine, and in the operating & maintenance instructions.**

**NOTE:** This sheet of instructions and safety information is not meant to cover all possible conditions and situations that may occur. Read entire Operating & Maintenance Instructions for this engine AND the instructions for the equipment this engine powers. Failure to follow instructions and safety information could result in serious injury or death.

The safety alert symbol () is used to identify safety information about hazards that can result in personal injury.

A signal word (DANGER, WARNING, or CAUTION) is used with the alert symbol to indicate the likelihood and the potential severity of injury. In addition, a hazard symbol may be used to represent the type of hazard.

 **DANGER** indicates a hazard which, if not avoided, will result in death or serious injury.

 **WARNING** indicates a hazard which, if not avoided, could result in death or serious injury.

 **CAUTION** indicates a hazard which, if not avoided, might result in minor or moderate injury.

**CAUTION**, when used **without** the alert symbol, indicates a situation that **could result in damage to the engine.**

## HAZARD SYMBOLS AND MEANINGS



Fire



Explosion



Moving Parts



Toxic Fumes



Hot Surface



Shock



Kickback

(OVER)

FORM MS-6445-01/03

# ENGINE SELECTION



 <b>WARNING</b>



<b>Failure to select the correct engine could result in fire or explosion.</b>



- Some engines are unique and designed for specific applications or types of equipment. If this engine will be used to build new equipment, contact Briggs & Stratton to ensure that the engine is appropriate for the intended use.  
**Note: For all Go-karts use only a model 136200 series engine, which offers improved safety and performance.**
- Replacement engines should be the same model as the original engine, or be the Briggs & Stratton designated replacement engine. Refer to the Operation & Maintenance Instructions for engine identification information.  
**Note: For all Go-karts use only a model 136200 series engine, which offers improved safety and performance.**
- Do not use Briggs & Stratton engines on 3-wheel All-Terrain Vehicles (ATVs), motor bikes, air craft products, or vehicles intended for use in competitive events. Briggs & Stratton does not approve of or authorize such uses.

# ENGINE INSTALLATION



- [1] Do not attempt to install this engine if you do not have the appropriate tools and knowledge of small engine installation procedures. Use only Briggs & Stratton parts. Contact your Authorized Service Dealer for assistance.
- [2] Do not modify the engine in any way without Briggs & Stratton factory approval. Any such modification is at the owner's sole risk.
- [3] If the exhaust system on the old engine was supplied by the equipment manufacturer, you must transfer the exhaust system and related components (original muffler and related pipes, brackets, clamps, and shields) to the new engine. All components must be in good condition.
- [4] 



 <b>WARNING</b>	Install muffler (and muffler deflector if used) so outlet points away from operator, fuel tank, and equipment, and so muffler heat will not damage or deform engine and components.
	
- [5] 



 <b>WARNING</b>	Ensure all fuel lines and fittings are properly assembled and do not leak. Replacement parts must be the same model as the original.
	
- [6] 



 <b>WARNING</b>	Ensure all wiring, including safety switches and engine shut-off components are completely installed and functioning properly.
	
- [7] Set engine speed to equipment manufacturer's specification. Refer to equipment manufacturer's manual. Do not tamper with governor springs, or other parts that will increase engine speed above specification.

- [8] 







 <b>WARNING</b>	All engine parts, including fuel cap, spark plug, muffler, air cleaner, and covers and guards for drive components (gears, belts, shafts, couplings, etc.) must be in place before attempting to start engine.
	
- [9] 

 <b>WARNING</b>	If engine is installed on walk behind lawn mower, all mower components, including cutting blade, must be correctly installed before attempting to start engine.
	
- [10] 

 <b>WARNING</b>	When working on the engine or equipment, remove spark plug wire from spark plug. For electric start, remove negative wire from battery.
	
- [11] 

 <b>WARNING</b>	Do not check for spark with spark plug removed. Use Briggs & Stratton spark tester #19368.
	

# ENGINE OPERATION

	 <b>WARNING</b>
	<b>When adding fuel:</b>
<p>Turn engine off and let engine cool at least 2 minutes before removing gas cap.</p> <p>Fill fuel tank outdoors or in well-ventilated area. Fill tank to about 1 inch below lowest portion of neck to allow for fuel expansion.</p> <p>Keep gasoline away from sparks, open flames, pilot lights, heat, and other ignition sources.</p>	
	 <b>WARNING</b>
	<b>When starting engine:</b>
<p>Remove all external equipment/engine loads.</p> <p>Wait until spilled fuel is evaporated. Start engine outdoors.</p> <p>Pull cord slowly until resistance is felt, then pull rapidly.</p> <p>If engine floods, set choke to OPEN/RUN, place throttle in FAST and crank until engine starts.</p>	
	 <b>WARNING</b>
	<b>When operating equipment:</b>
<p>Do not tip engine or equipment at angle which causes gasoline to spill.</p> <p>Run engine outdoors. Do not run in enclosed area, even if doors or windows are open.</p> <p>Do not choke carburetor to stop engine.</p>	

# Starting the Model "WM" Motor

	Paragraph		Paragraph
Before Starting the Motor.....	1	How to Stop.....	4
How to Start.....	2	General Data.....	5
Failure of Motor to Start.....	3		

**1. BEFORE STARTING THE MOTOR.** Fill the crankcase with Mobiloil Arctic or any other high grade oil not heavier than S. A. E. No. 20. A HEAVIER OIL MUST NOT BE USED. Remove blue oil filler plug, slowly pour the oil directly on top of the oil drain plug so that the oil runs down the sides of the plug into the reservoir. This will prevent spilling. Crankcase holds  $\frac{1}{2}$  pint. Fill the gas tank with a good grade of clean regular gasoline. Tank holds 1 quart. Do not mix oil and gasoline. See paragraphs 11 to 19.

**2. HOW TO START.** Pull up the carburetor choke knob. Step down **quickly** on starter pedal and repeat **rapidly** until motor fires. As the motor warms up, gradually adjust choke until motor operates smoothly. Operate carburetor choke the same as you operate the choke on your automobile. A hot motor does not require as much choking as a cold motor. See paragraph 20.

**3. FAILURE OF MOTOR TO START.** If motor fails to start after a reasonable number of trials do not make any adjustments until you have studied the instructions referred to in the **Servicing Reference Chart**, on page 4.

**4. HOW TO STOP.** Pull the choke knob all the way out and hold until motor stops firing.

**5. GENERAL DATA.** You will find your Briggs & Stratton motor substantially built. It is made of high grade materials by skilled workmen, in a factory fully equipped with the most modern machinery. Before it was shipped, it received many tests and careful inspections.

**6.** Your motor will give you better service if you do not tinker with it. This does not mean, however, that it does not require a certain amount of attention. Give it the right kind of fuel, oil and care. Keep it clean both inside and out. You will be well repaid in trouble-free, satisfactory service.

**7.** If you should experience any difficulty, follow the instructions referred to in the **Servicing Reference Chart** on page 4. If you cannot easily remedy it, consult your dealer, or a nearby Briggs & Stratton Authorized Central Service Distributor. See page 15.

Briggs & Stratton 4-Cycle Motor, Model "WM" — Plate No. 1

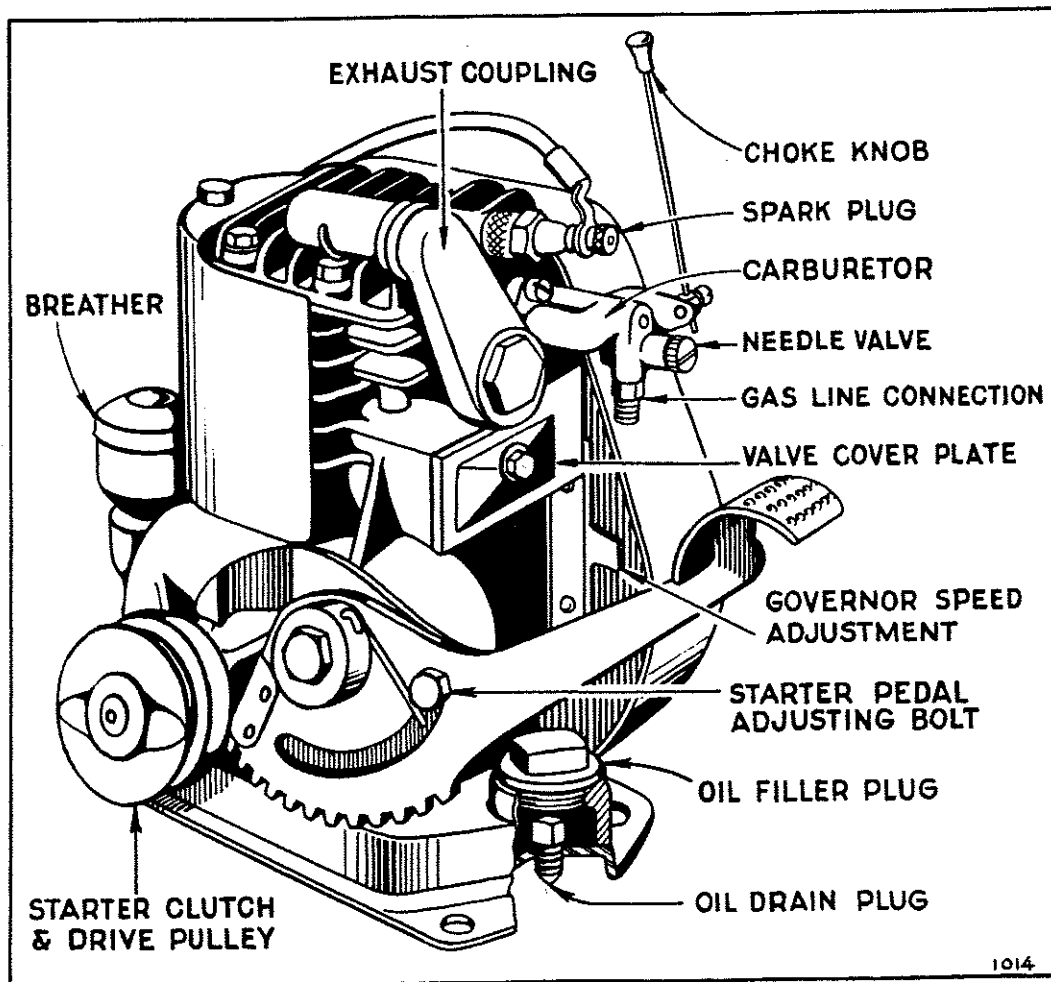

1014

# Servicing Reference Chart

## MOTOR FAILS TO START

	Paragraph
Out of Gasoline.....	1-16
Out of Oil.....	1-13-52
Dirt or Gum in Fuel System.....	16 to 19
Incorrect Use of Choke.....	20
Carburetor Out of Adjustment.....	22 to 25
Spark Plug Dirty.....	29-30
Ignition Cable Grounded.....	31
Magneto.....	32 to 40
Poor Compression.....	41 to 49
Starter Clutch.....	60

## MOTOR STOPS

Out of Gasoline.....	1-16
Out of Oil.....	1-13-52
Dirt or Gum in Fuel System.....	16 to 19
Motor Overheated.....	13-52-54-58
Motor Overloaded.....	58

## MOTOR OVERHEATS

	Paragraph
Out of Oil.....	1-13-52
Oil Needs Changing.....	14-15
Oil Too Heavy.....	14-15
Carburetor Out of Adjustment.....	22 to 25
Poor Spark.....	28 to 40
Carbon.....	54
Overloaded.....	58

## MOTOR LACKS POWER

Lack of Oil.....	1-13-52
Add or Change Oil.....	13 to 15
Carburetor Out of Adjustment.....	22 to 25
Motor Not Up to Speed.....	26-27
Poor Spark.....	28 to 40
Poor Compression.....	41 to 49
Carbon.....	54
Air Cleaner Clogged.....	55
Muffler or Exhaust Hose Fitting Clogged.....	56
Exhaust Tubing.....	57
Overloaded.....	58

# Instructions for Adjustment and Repair

	Paragraph		Paragraph
Operating Requirements.....	8	Magneto Timing.....	35
How a 4-Cycle Motor Works.....	10	To Adjust and Clean Contact Points.....	36
Keep the Motor Clean.....	11	To Replace Condenser.....	37
Use the Right Kind of Oil.....	12	To Replace and Adjust Armature.....	39
Add Oil Regularly.....	13	Cylinder Head.....	41
Change Oil Frequently.....	14	Compression.....	42
Use Clean Gasoline.....	16	Valve Adjustment.....	43
Avoid Gummy Gasoline.....	17	Piston.....	47
To Clean the Fuel Lines.....	19	Piston Rings.....	49
Correct Use of the Choke.....	20	Piston Pin.....	50
To Prime the Motor.....	21	Connecting Rod.....	51
To Adjust the Carburetor.....	22	Oil Pump.....	52
To Remove and Replace Carburetor.....	24	Oil Leaks.....	53
To Remove and Replace Carburetor Throttle Governor—Correct Motor Speed.....	25	Carbon.....	54
.....	26	Air Cleaner.....	55
The Ignition System.....	28	Muffler or Exhaust Hose Fitting.....	56
To Check for Spark.....	29	Exhaust Tubing.....	57
Spark Plug Adjustment.....	30	Overload.....	58
Ignition Cable.....	31	Starter Pedal Adjustment.....	59
To Remove and Replace Flywheel.....	32	Starter Clutch.....	60
To Remove and Replace Magneto.....	34	Parts.....	61

8. **OPERATING REQUIREMENTS.** A gasoline motor to operate properly must have all parts in correct adjustment to provide good ignition, carburetion, compression and cooling. And of equal importance, the oil and gasoline used must be clean and of the recommended grades. The following instructions fully explain the simple adjustments and offer operating recommendations that will

assure you complete satisfaction. We urge you to carefully observe them.

9. The reliability, economy and ease of starting which characterize this motor are due in part to the fact that it is of the 4-stroke cycle design commonly called "4-cycle," the same design used in all automotive motors. As the name indicates there are four strokes to one complete power cycle.

**10. HOW A 4-CYCLE MOTOR OPERATES.** On the intake stroke the piston goes down, producing a vacuum in the cylinder, thereby drawing fuel up through the carburetor so that the space above the piston becomes filled with combustible gas. During this stroke the intake valve is open. Next the piston comes up on the compression stroke with both valves closed. At the top of the compression stroke a spark occurs at the spark plug, firing the highly compressed gas. This produces an explosion above the piston which forces it down on the power stroke. Both valves are closed. On the next upstroke of the piston, called the exhaust stroke, the exhaust valve is open, and the burned gases driven out. See plate No. 2.

The 4-Stroke Cycle  
Plate No. 2

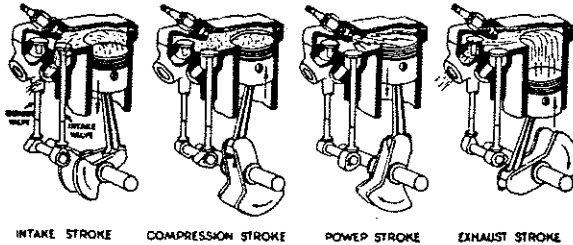

**11. KEEP THE MOTOR CLEAN.** It will pay you to keep your motor clean both inside and outside. See that no dirt or water enters motor when filling with oil or gasoline. As a precautionary measure always wipe off the gasoline cap and oil filler plug, as well as around them before refilling. Dirt in the motor or gasoline tank will cause trouble and even serious damage.

**12. USE THE RIGHT KIND OF OIL.** Correct lubrication is important. We recommend the use of MOBIL OIL "ARCTIC" or other high grade oil with similar characteristics having a low carbon residue and a body not heavier than S. A. E. No. 20. A heavier oil which might be satisfactory in a tractor or for lubricating farm machinery must NOT be used. Do not mix oil with the gasoline. This 4-cycle motor is provided with an independent efficient pump and splash lubrication system. The pump maintains the proper oil level in the oil trough and a dipper on the connecting rod dips into the trough throwing the oil to all moving parts. There are no external parts which require separate oiling.

**13. ADD OIL REGULARLY.** A motor which is run without oil will be ruined within a few minutes. To avoid the possibility of such an occurrence and the resulting expense, always fill the oil reservoir at the blue plug to the top of the filler plug opening after each five hours of motor operation. Capacity of oil reservoir is  $\frac{1}{3}$  pint.

**14. CHANGE OIL FREQUENTLY.** After every twenty-five hours of motor operation, the oil should be completely drained from the crankcase. Do not remove motor from its mounting base. Remove blue oil filler plug and use special wrench furnished with your motor to unscrew oil drain plug located in base plate and remove it through oil filler opening. The old oil will drain straight down through this hole in the base plate into the pan or other receptacle you use. See plate No. 3. We do not recommend flushing out with kerosene. Replace the drain plug, refill with fresh oil and replace the blue filler plug.

**15.** In the normal running of any motor, small particles of metal from the cylinder walls, pistons and bearings will gradually work into the oil. Dust particles from the air also get into the oil.

Sludge, a gummy mass, forms which clogs up the oil passages. If the oil is not changed regularly, these foreign particles cause increased friction and a grinding action which shortens the life of the motor. Fresh oil also assists in cooling, for old oil gradually becomes thick and loses its cooling as well as its lubricating qualities.

How to Drain Oil  
Plate No. 3

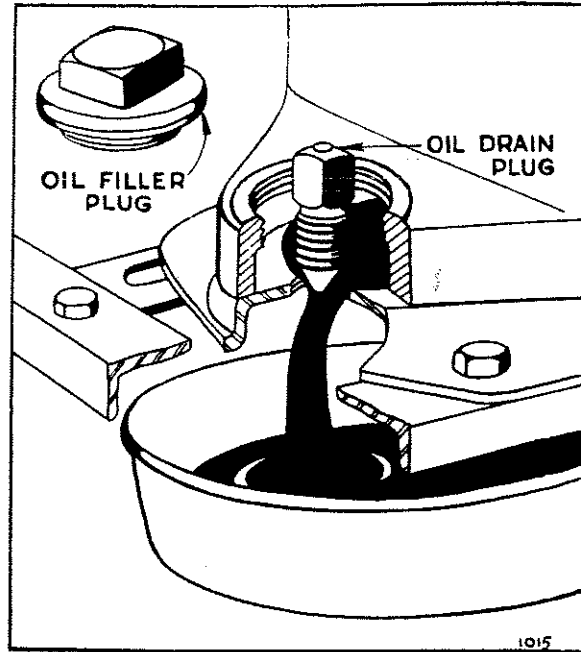

**16. USE CLEAN GASOLINE.** A good grade of clean, fresh, regular gasoline is recommended. Too high test gasoline may form vapor-lock in gas line when motor gets hot. This interrupts the flow of gasoline and causes motor to stop. Be sure that the small vent hole in the gasoline tank cap is not clogged up, for air must enter the tank to allow the gasoline to flow to the carburetor. Test by blowing through top of cap.

**17. AVOID GUMMY GASOLINE.** If you experience trouble with a gummy, sticky substance with a peculiar sharp obnoxious smell, change to another grade of gasoline. This gum comes from the gasoline and clogs carburetor, gas line, gasoline tank check valve, etc. You can check your gasoline by evaporating a half pint in an open dish. If a quantity of gum remains, try another kind that is clean and fresh.

**18.** You can avoid most trouble from gum if you will keep the tank full when you are not using the motor. If you use it only occasionally, drain tank completely and refill when motor is used again. The reason for this is that evaporation of stale gasoline causes most gum deposits.

**19. TO CLEAN THE FUEL LINES.** Disconnect the gasoline line at the carburetor and also at the gas tank. Blow through the gas line to clear. Remove the gas tank feed pipe which is screwed into the gas tank proper. At its base you will find a screen which may be clogged. To determine whether this pipe itself is clear, blow through the pipe from the screen end. There is a check ball in the base of this pipe which must be free. See plate No. 4. Check ball must close air passage when blowing through opposite end of pipe. When replacing gas pipe in tank,

be sure to place gasket between gas tank and gas pipe nut. **IMPORTANT:** If you find a gummy varnish-like substance, alcohol or acetone will dissolve it. See paragraphs 17 and 18.

**Gas Pipe**  
Plate No. 4

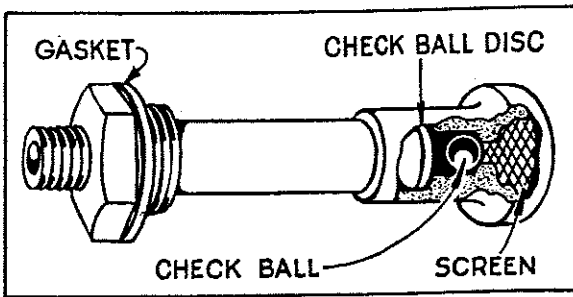

**20. CORRECT USE OF THE CHOKE.** The correct carburetor setting (see paragraph 23) gives the motor the best mixture to run on when it is hot. For starting, it is necessary to choke the carburetor to get a rich mixture, because cold gasoline does not vaporize readily. A warm or hot motor requires very little choking. Until you become familiar with your motor, however, you may make the mistake of not choking the carburetor enough or you may choke it too much. If motor fails to start after cranking three or four times with the choke up, or closed, try cranking two or three times with the choke part way down and then all the way down, or open. Use motor choke the same as you use an automobile choke.

**21. TO PRIME THE MOTOR.** The motor may fail to start for the reason that either the carburetor is incorrectly adjusted or dirty, or the fuel line or gas pipe check valve in the gasoline tank is dirty or clogged, or you are out of gasoline. To determine the cause, prime the motor by removing the spark plug and pour a half teaspoonful of gasoline into the spark plug opening. Replace the spark plug and crank the motor. If it fires for three or four revolutions and stops, the difficulty is definitely in the fuel system. See paragraphs 19, 22 to 25. If motor will not fire at all, check the ignition system, see paragraphs 28 to 40; also compression, paragraphs 42 to 49.

**22. TO ADJUST THE CARBURETOR.** The carburetor on the Model "WM" motor is of the suction type. The gasoline supply is regulated by a needle valve. The throttle is automatically controlled by the governor, see paragraph 26.

**23.** To adjust the carburetor, completely close needle valve by turning to right or clock-wise as far as possible. Do not screw up too tight or use force when closing needle valve, or the seat, or taper of needle valve may be damaged. From closed position, open needle valve one complete turn. After the motor has been started and warmed up with the choke wide open, make final adjustment by turning the needle valve to the point at which motor operates most smoothly with full load. This setting will also take care of starting with use of the choke. When starting cold motor, if it is necessary to keep choke partially closed several minutes before motor runs smoothly, carburetor setting is too lean and needle valve should be opened a notch or two—turn to left. If carburetor throttle acts sluggish or motor does not govern smoothly, it is usually caused by a dirty or gummy throttle. See paragraph 25. For governor adjustments see paragraph 26.

**24. TO REMOVE AND REPLACE CARBURETOR.** Disconnect gasoline line from carburetor. Remove blower case. Remove the governor blade by pulling out the governor rod and spacer washer which holds it in place. See plate No. 5. Remove valve cover plate. Loosen two carburetor mounting bolts. Carefully

remove carburetor and, without stretching governor spring, unhook its lower end. Do not remove governor spring or link from throttle arm. To replace, reverse the operations as performed above, inserting spacer washer between outside governor blade bearing and governor rod ear.

**Carburetor and Governor Hook-up**  
Plate No. 5

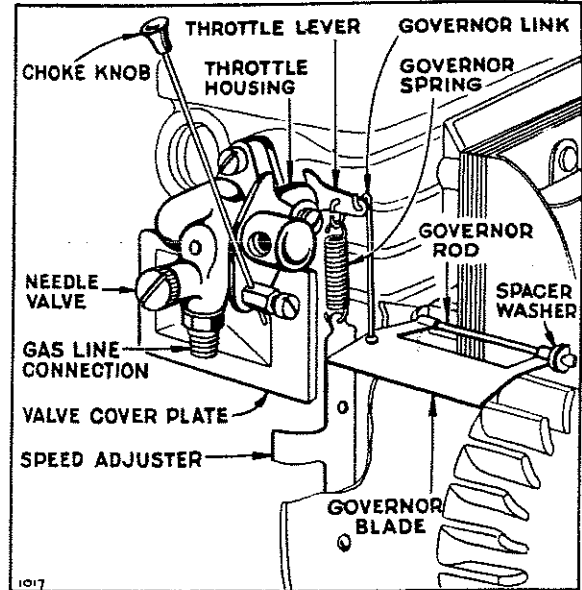

**25. To Remove and Replace Carburetor Throttle.** On models with die cast throttle lever and throttle (see plate No. 9, Fig. 1). To clean the carburetor throttle, remove the carburetor as explained in paragraph 24. Then remove throttle cotter pin and washer and slip throttle from body. Clean in alcohol or acetone. Do not scrape.

On models with steel throttle lever and brass sleeve (see plate No. 9, Fig. 2).

**Carburetor Throttle**  
Plate No. 9, Fig. 1

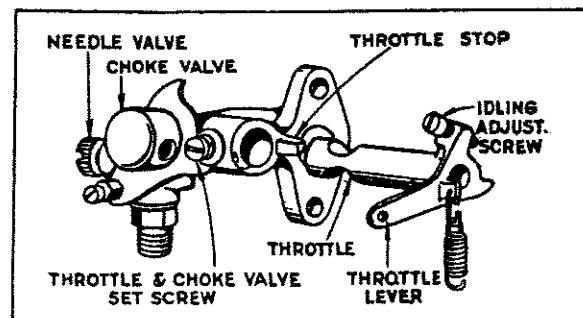
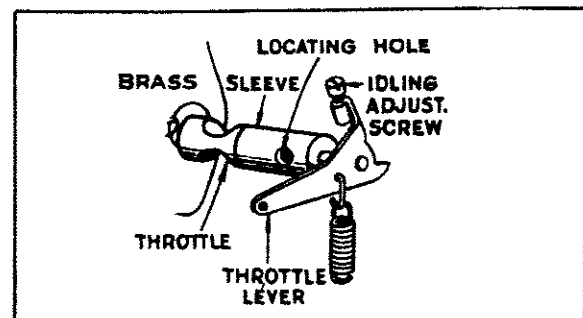

Plate No. 9, Fig. 2





To clean the carburetor throttle, remove the carburetor as explained in paragraph No. 24. To remove the throttle, loosen the set screw which holds the choke valve and carburetor throttle in place. The throttle is easily removed with the fingers. The throttle is part of an assembly consisting of the throttle, sleeve, throttle lever and governor spring. Clean in alcohol or acetone. Do not scrape. To reassemble, replace choke valve, insert throttle assembly into the carburetor body as far as it will go, lining up holes in sleeve with locating hole in body and with throttle stop between forked points of throttle lever. Push the sleeve of throttle in place by inserting a small tool between throttle lever and sleeve, so that set screw holes line up. Tighten set screw, being sure that choke valve friction spring, plain washer and lockwasher are in proper place.

**26. GOVERNOR—CORRECT MOTOR SPEED.** The speed of your model "WM" motor is automatically maintained under varying loads by a pneumatic governor. It is operated by the air current blown by the flywheel.

**27.** The governor was carefully adjusted at the factory to maintain normal speed under load. Do not re-adjust unless absolutely necessary. A sliding speed adjuster is located beneath carburetor. Moving the slide down increases motor speed, up decreases motor speed. Tap lightly to adjust. See plate No. 5. Recommended speed is from 2200 to 2400 R.P.M. The idling speed is set at 1100 R.P.M. On washing machine application, adjust motor speed to operate washing machine agitator at speed recommended by the manufacturer of your washer. To remove or replace governor parts, see paragraph 24.

**28. THE IGNITION SYSTEM.** The spark is produced by a high tension magneto consisting of armature, condenser, contact points and rotating magnets cast in the flywheel. This is a simple self-contained system which is very reliable. It also does away with batteries. The ignition current is sent into the motor cylinder through the ignition cable and spark plug. The magneto itself as well as the cable and spark plug must all be in proper condition and adjustment to insure a good hot spark.

**29. TO CHECK FOR SPARK.** To prove that a satisfactory spark is being delivered by the magneto, remove the ignition cable from the plug. Hold ignition cable terminal about  $\frac{1}{8}$ " from any metal part of the cylinder head (keep hand on insulated part of the cable to avoid a shock). Turn motor with starter, and if the spark jumps this gap the entire ignition system, with the exception of the spark plug, is O. K. See plate No. 7. (To check spark plug see paragraph 30.) If no spark, check cable, see paragraph 31, and refer to magneto adjustments paragraphs 32 to 40.

Checking Spark  
Plate No. 7

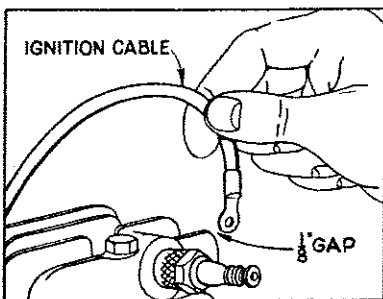

Spark Plug  
Plate No. 8

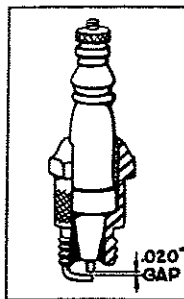

**30. SPARK PLUG ADJUSTMENT.** Spark plugs should be cleaned occasionally and points reset to .020". Points burn away in service. The porcelain is to prevent the spark from jumping anywhere except at the gap, and if cracked or broken it will prevent plug firing. Water on the outside of the spark plug may permit the high voltage current to leak over the surface of the porcelain. Dirt or carbon on it will do the same thing. Always keep

a new plug on hand. We recommend the use of Champion No. J8 or its exact equivalent.

**31. IGNITION CABLE.** Insulation must not be broken or soaked with oil or water or grounded in any way where it touches the motor, or it will interfere with good ignition. To check cable all the way to magneto it is necessary to remove blower case. Ignition cable should be securely wound to the secondary terminal loop of the coil. See plate No. 12.

**32. TO REMOVE AND REPLACE FLYWHEEL.** The flywheel is securely mounted to the crankshaft by means of a taper fit, a key, a LEFT hand nut and a spring washer. Remove the blower housing. Bolt or clamp motor to work bench. Place a wood block under flywheel fin on right side of flywheel or a small rod between fins, to hold it rigid and prevent turning as you loosen nut. See plate No. 9. Use large wrench, 10-inch or bigger. To start nut, to the RIGHT, tap end of wrench handle lightly with hammer. Tap carefully or a broken fin may result which will throw flywheel out of balance. After nut is removed, loosen flywheel by placing the wood block against end of crankshaft and striking with a hammer. Pull off flywheel.

Removing Flywheel  
Plate No. 9

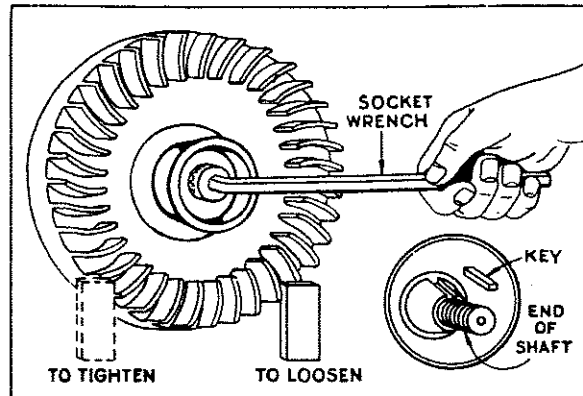

**33.** To reassemble, locate flywheel on crankshaft with key and install spring washer with the hollow or concave side next to the flywheel. Turn nut to LEFT until tight. Then use block under fin on left side of flywheel or rod between fins to hold flywheel rigid and draw nut up very tight by tapping wrench handle with hammer.

Correct End Play  
Plate No. 10

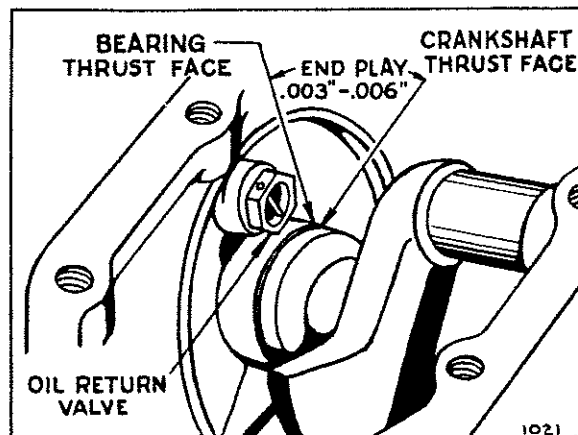

**34. TO REMOVE AND REPLACE MAGNETO ASSEMBLY.** After removing the flywheel as explained in paragraph 32, remove cover plate from the valve chamber, remove carburetor, see paragraph 24, unhook governor spring, detach the ignition cable from spark plug, and unscrew the four magneto plate mounting screws. To replace use same gasket between the plate and crankcase, or, if damaged, a new gasket, see part numbers 67307, 67597, 67607, of proper thickness to get correct end play of .003" to .006" between magneto bearing and crankshaft thrust faces, as shown in plate No. 10. Use lockwashers under mounting screws.

**35.** Magneto assembly is always correctly timed with the motor when the flywheel is assembled to the tapered crankshaft with a key and securely held in place with LEFT hand threaded nut.

Do not attempt to change the timing by relocating any parts or filing crankshaft timing flat. Always use soft key part No. 61760 — If steel key is used and flywheel becomes loose, it will damage the keyway in the crankshaft.

**36. TO ADJUST AND CLEAN CONTACT POINTS.** Remove blower housing and flywheel. Turn crankshaft by hand to see if contact points open and close properly. Points must be clean and line up squarely to make good electrical contact. Do not file contact points — use fine sand paper or fine grit hone to clean points. Adjust gap to .020" by loosening the adjusting lock screw and moving contact point bracket up or down. When proper gap is obtained tighten lock screw securely. If either or both points become badly pitted or burned and need replacement, always order complete assembly Part No. 29667.

**37. TO REPLACE CONDENSER.** A leaky or weak condenser may cause the motor to start hard, to sputter or misfire under load. If motor misfires after checking gasoline line, carburetor, spark plug, cable and contact points, install a new condenser. Both the condenser lead and armature lead must be soldered to brass arm, see plate No. 11. Be sure to push condenser lead down between condenser and hub of magneto plate so it cannot rub against flywheel.

**38.** If after new condenser has been installed the ignition system does not deliver a satisfactory spark, we recommend sending the complete magneto and the flywheel to the nearest Briggs & Stratton Central Service Distributor, listed on page 15, for proper adjustment.

Contact Points and Condenser  
Plate No. 11

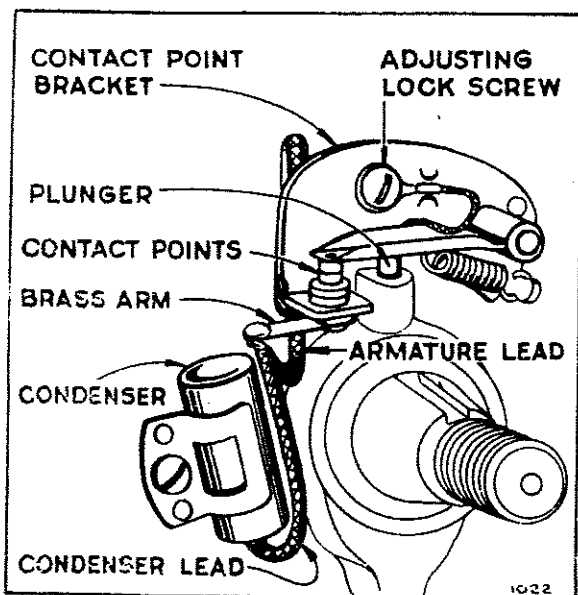

**39. TO REPLACE AND ADJUST ARMATURE.** Remove primary armature lead wire of coil from brass arm on contact bracket. Remove high tension ignition cable from secondary terminal loop in coil. Unscrew four armature mounting screws. After installing new armature be sure that condenser lead wire and armature lead wire from coil are soldered to brass arm on contact bracket. See plates Nos. 11 and 12. Replace mounting screws inserting loop of ground wires under screw and draw screws up tight.

**40.** Air gap of .008" to .012" must be maintained between armature core ends and flywheel. Gap must only be sufficient to prevent rubbing but not over .012", or poor ignition will result. To adjust gap to proper clearance, loosen the four armature mounting screws, slide armature assembly up and place correct feeler gauge or 3 thicknesses of newspaper between rim of flywheel and armature core ends. Lower armature assembly until core ends rest on gauge or paper and tighten mounting screws securely. See plate No. 12.

Complete Magneto Assembly  
Plate No. 12

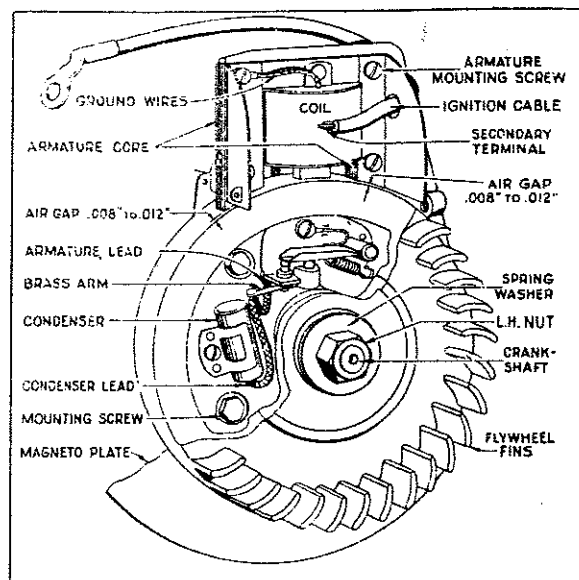

**41. CYLINDER HEAD.** The cylinder head is held on with six cap screws. When the cylinder head has been removed for the purpose of cleaning carbon or grinding valves, care should be used in replacing it. Use a new gasket if possible. Otherwise clean the old one and coat both sides with cup grease. We do not recommend the use of shellac on cylinder head gaskets. Tighten each cap screw a little at a time so that the cylinder head is pulled down evenly. Screws need be only moderately tight.

**42. COMPRESSION.** Proper compression is obtained when valves seat properly, gaskets do not leak and piston and rings are properly fitted. When tuning up a motor, it is always well to check compression. This is done by turning the motor over slowly. If a point of resistance is offered every other revolution, compression should be satisfactory. If motor turns over without compression resistance for a full cycle, a worn piston, piston rings, cylinder wall, or leaky valves or leaky gaskets are present. See that spark plug has a gasket under it and is drawn up tight. Also check cylinder head gasket and tighten cylinder head bolts.

**43. VALVE ADJUSTMENT.** To check valve clearance remove valve cover plate on cylinder below carburetor. The correct clearance on the exhaust valve is .008" and on the intake valve .006" when the motor is cold. Tappet clearance is adjusted by grinding required amount from the end of valve stem. End of stem must be square with the stem proper.

44. To remove the valves, remove cylinder head and, if not dismantled, drain oil from crankcase. Invert cylinder. Compress the valve spring with a screw driver and pull out valve retainer pin with long nose pliers. Tilt cylinder back far enough to allow valve to drop, permitting its stem to clear the spring. Pry the spring out with screw driver. To replace, reverse the operations as performed above.

45. To reseat valves, grind in same manner as automobile valves. If valves stick they may be coated with gum or carbon. To remove gum use alcohol or acetone. Clean valve stems thoroughly with wire brush or emery cloth. Also scrape all carbon from valve ports.

46. The timing of the valves is taken care of by the meshing of the cam gear with the gear on the crankshaft. These gears are properly meshed when the mark on the cam shaft gear is in line with the mark on the crankshaft collar.

Valve Timing — Plate No. 13

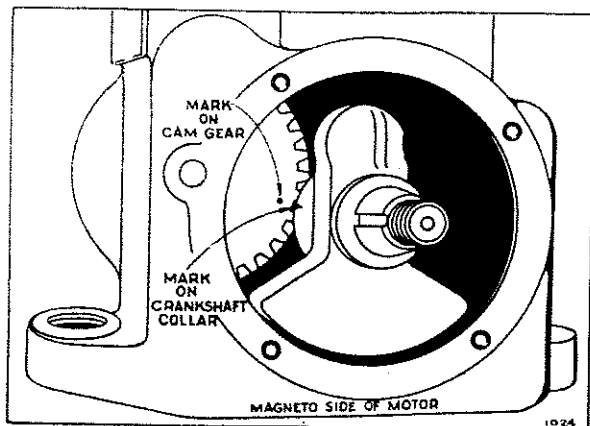

47. **PISTON.** The piston in the model "WM" motor is made of a special aluminum alloy which is very light in weight. The clearance between the piston and cylinder wall is .005" to .0065". This clearance is to compensate for the expansion of aluminum when hot. When piston is removed be sure to clean carbon from head of piston and ring grooves. If piston is out of round or scored it should be replaced.

48. When fitting a new piston in the motor, assemble it with the free side pin hole (indicated with an "X" on boss) toward the magneto side. If an oversize piston is necessary, we recommend that reboring of cylinder be done by an Authorized Central Service Distributor or the factory.

49. **PISTON RINGS.** The piston rings when fitted in the cylinder should have a gap from .007" to .015". The rings should be fitted in the cylinder below the piston ring travel. Before assembling new rings to piston be sure that piston ring grooves are thoroughly cleaned, and rings fit free in the grooves.

50. **PISTON PIN.** The piston pin is a free fit in one side of the piston and a tight fit in the other. To remove this pin without special equipment, it is advisable to heat the piston in boiling water which causes the aluminum to expand. Cut a wooden pin a little smaller than the size of the piston pin and use this and a hammer to drive the pin out. Drive the pin out through the free fit hole. This hole is toward the magneto side and is indicated with an "X" on the pin hole boss. You should, of course, drive the pin out while the piston is still hot. To easily replace the pin, the piston should be heated.

86. **CONNECTING ROD.** The connecting rod is also made of special aluminum alloy which combines strength with light weight. The style of rod used on model "WM" motors varies, therefore be sure to read the following instructions carefully before ordering new rods or parts.

Connecting Rod — Plate No. 14

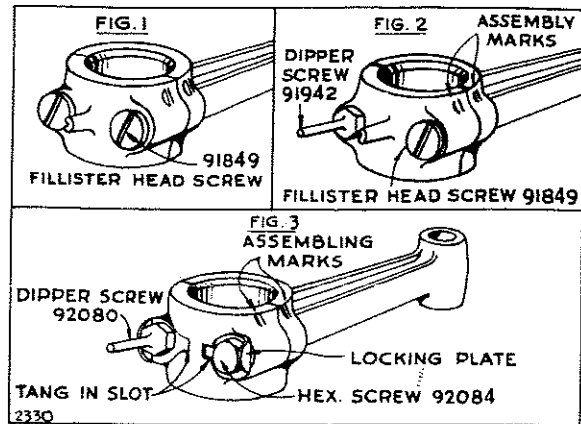

The connecting rod shown in Fig. 1 is used on motors with an oil pump. The cap is fastened with two No. 91849 fillister head screws. If screws only are needed, order by this number. Later "WM" models do not have oil pumps and are supplied with rod illustrated in Fig. 2. The cap is locked with one No. 91849 fillister head screw and one No. 91942 dipper screw. If screws only are needed, order these numbers. If you desire to replace either of the above rods (Figs. 1 or 2) with a complete new connecting rod assembly, order part No. 29733 (Fig. 3). However, on rod in Fig. 1 be sure to also order new base plate No. 62904. This is the latest improved type and will operate efficiently in your motor. When assembling connecting rod to crankshaft the assembly marks on the lower bearing must be toward carburetor side.

52. **OIL PUMP.** The oil pump is permanently assembled to the base. An inoperative pump will result in insufficient lubrication which may score cylinder and piston assembly. To check oil pump, remove base screws. Place pump and base assembly in pan of oil about 1/4" below top of oil trough. Work plunger up and down. If oil trough fills up, oil pump is in good operating condition. If clogged send your motor to the nearest Briggs & Stratton Central Service Distributor listed on page 15 for special oil system change-over.

Oil Pump — Plate No. 15

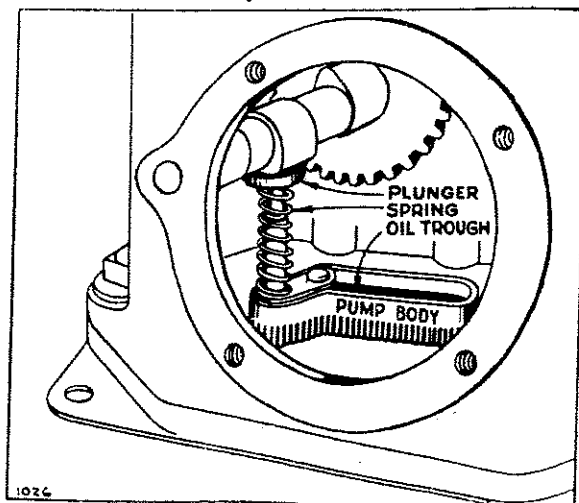

**53. OIL LEAKS.** If oil leaks from either end of crankshaft, remove base plate from motor. Oil return valves are screwed into crank case and magneto back plate at base of main bearings. Remove oil return valve and clean or flush with gasoline and blow out any dirt lodged under the small disc. See plate No. 10.

**54. CARBON.** Excessive carbon is caused by improper grade of oil — too much oil, usually the result of piston rings not seating properly or sticking — carburetor set too rich — or long service. An unusual amount of carbon is noticeable by motor knocking or loss of power. Occasionally remove carbon from piston head, cylinder head and top of cylinder bore.

**55. AIR CLEANER.** If an air cleaner is used it should be occasionally removed and cleaned by washing in kerosene, then dipped in oil to make it efficient in catching dust. Test to see if it is clogged by noting if motor performs better with it off. If clogged it should be replaced.

**56. MUFFLER OR EXHAUST HOSE FITTING.** After long periods of service it is possible that the muffler, exhaust hose fitting, or the exhaust tubing will become clogged and reduce motor power. To check the muffler run water into the open end. If full streams of water come out of the small holes at the opposite end it is O.K. If not, it should be replaced. Exhaust hose fitting is removed by unscrewing nut — holes should be fully open.

**57. EXHAUST TUBING.** A certain amount of water forms inside of the exhaust tube after it cools off due to condensation. After motor is stopped, place exhaust tube so that water from condensation cannot drain into exhaust port of motor to corrode the mechanical parts and eventually result in trouble. If exhaust pipe is too long, or clogged, back pressure will reduce motor power.

**58. OVERLOAD.** Always be sure that the machine the motor is operating is well lubricated and running freely. If it is not, it may cause the motor to become overloaded resulting in it overheating, losing power, or even stopping entirely.

**59. STARTER PEDAL ADJUSTMENT.** The starter pedal is made in two parts, the pedal proper and pedal stop, held together with the adjusting bolt. To adjust, loosen the bolt and set pedal to desired position. Adjust the pedal to get the longest possible stroke without striking any part of the machine. The first tooth on the starter sector must clear the teeth of the starter pinion. Should the starter pedal return spring loosen or lose its tension, loosen the bolt which holds the return spring cup. Turn the cup to the left until there is just enough tension to return the starter pedal back to the normal position after depressing it, and tighten the bolt. Too much tension may cause spring to break. Be sure the spring is in the proper position with the long end below the pedal adjusting bolt and the hooked end in the slot of the cup.

Starter Pedal Adjustment  
Plate No. 16

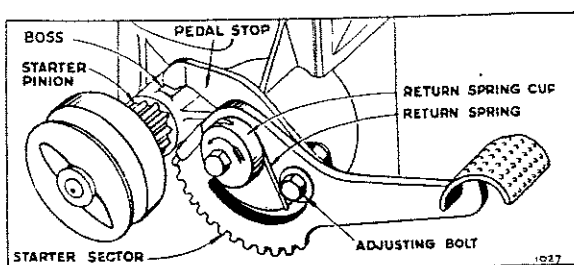

**60. STARTER CLUTCH.** If the starter clutch slips or fails to turn the motor, when stepping on the starter pedal, it is probably caused by one of the following reasons:

- Loose set screw.
- Worn clutch housing.
- Worn or broken pinion.

First tighten the set screw to be sure clutch is tight on the crankshaft. Use  $\frac{1}{8}$ " Allen hexagon set-screw wrench. If the clutch still slips, loosen set screw and remove clutch from the shaft. Pry out the snap spring with a sharp tool, holding the clutch in the position shown in plate No. 17, as a caution against the spring jumping out. Check the parts carefully for wear or damage and replace those necessary. To reassemble, replace the parts in the same order, and slip the spring back in place. Replace pulley clutch on shaft with the set screw hole lined up with recess in crankshaft extension. Securely tighten set screw.

Starter Clutch  
Plate No. 17

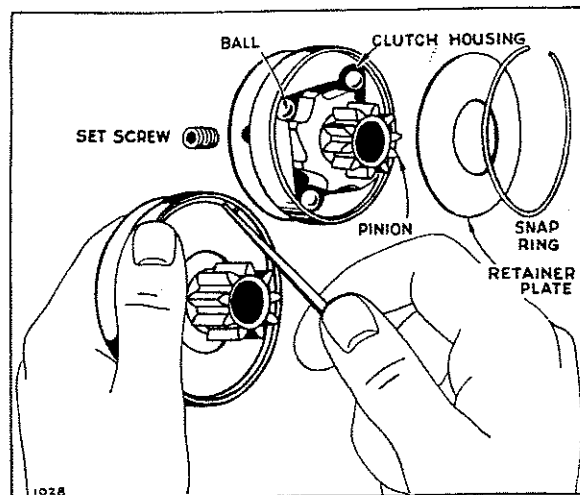

**61. PARTS.** All parts should be ordered from your dealer or the nearest Authorized Briggs & Stratton Service Distributor, listed on page 15.

**62.** To assure continued satisfactory performance, do not attempt to use substitute repair parts when overhauling or repairing the Briggs & Stratton Motor. Insist that all repair parts be original Briggs & Stratton parts.

**63. ALWAYS GIVE TYPE, MODEL AND SERIAL NUMBERS.** Briggs & Stratton motors are identified by a type number, model letter and a serial number. This information is stamped on a metal plate attached to the blower housing.

**64.** When writing to the factory or to a Central Service Distributor for service information, or when ordering new parts, be sure to specify the type number, the model, and the serial number of the motor to be serviced. This will assure prompt and efficient service without unnecessary correspondence.

**65.** Shipments will be made C.O.D. or send remittance with order to cover parts and add what you think will be sufficient for postage. Send postal or express money order, bank draft or certified check for this amount. Do not send currency in a letter. It is not safe.

**66. PRICES.** All prices in this book are subject to change without notice. In case of change in prices, orders will be filled at current prices. All prices shown are F.O.B. Factory at Milwaukee, Wis., or nearest Authorized Central Service Distributor. Prices higher in Canada.

## TO FIND THE CORRECT NUMBER OF THE PART YOU NEED

1. Make a note of your motor TYPE NUMBER (Not the Serial Number) that appears on the metal nameplate attached to motor blower housing.
2. Refer to pages illustrating parts and locate the Master Part Number by comparing your old part with the illustrations. Assemblies include all part numbers bracketed in illustration. All parts shown in assembly brackets on which part numbers are given can be purchased separately.
3. After the Master Part Number has been identified, refer to the following Parts List where these Master Part Numbers are listed in numerical order.

**The Master Part is used on all types of motors except those types listed under "Note."**

4. If a "Note" appears below the Master Part Number, this means that this part is made different from the Master Part for certain types and if your type is listed under "Note," order the part referred to.
5. If two or more parts are bracketed ( ) under "Note," they are used to replace the Master Part on the type numbers shown.
6. If your Motor Type Number does not appear after any part number listed under "Note," order the Master Part Number.
7. When ordering parts—or writing for service information — always specify the MODEL LETTER — TYPE NUMBER — and SERIAL NUMBER of your motor.

# Model "WM" Parts List

MASTER PART NUMBER	NAME	SHIPPING WEIGHT Lbs. Oz.
21283	Ring—Piston, Compression, Top-Standard.....	1
21310	Body—Breather .....	1
	Used on engines with inside breather.	
21376	Ring—Piston, Compression, Top-.010" O.S.....	1
21377	Ring—Piston, Compression, Top-.020" O.S.....	1
21378	Ring—Piston, Compression, Top-.030" O.S.....	1
22011	Cover—Valve .....	6
22020	Washer—Throttle Shaft Retainer.....	1
22082	Lock—Connecting Rod Screw.....	1
22206	Shield—Cylinder .....	6
22216	Cover—Breather .....	1
	Used on engines with inside breather.	
22217	Shield—Oil Spray.....	1
	Used on engines with inside breather.	
	<b>Note: No. 62703</b> Shield—Oil Spray.....	1
	Used on engines with outside breather.	
22353	Washer—Valve Cover.....	1
22360	Spacer—Governor Blade.....	1
22368	Washer—Control Lever.....	1
22725	Washer—Control Lever.....	1
22834	Washer—Spacer .....	1
23068	Nut—Speed Adjusting.....	1
23069	Screw—Speed Adjusting.....	1
23187	Pin—Valve Spring Retainer.....	1
23444	Stud—Valve Cover.....	1
	Used on engines with inside breather.	
	<b>Note: No. 91707</b> Screw—Valve Cover.....	1
	Used on engines with outside breather.	
23495	Ring—Oil Retainer.....	1
23571	Swivel—Control Lever.....	1
23580	Bushing—Control Lever.....	1
26012	Crankshaft .....	3
	<b>Note: No. 26051</b> Crankshaft.....	3
	Used on type Nos. 60915, 60961.	
26021	Spring—Valve .....	1
26025	Spring—Pedal Return.....	1
26026	Lock—Piston Pin.....	1
26032	Spring—Clutch Retainer.....	1
26034	Link—Governor .....	1
26035	Spring—Stop Pin.....	1
26328	Spring—Governor .....	1
26330	Spring—Breather Retainer.....	1
	Used on engines with inside breather.	
26657	Spring—Throttle Adjustment.....	1

MASTER PART NUMBER	NAME	SHIPPING WEIGHT Lbs. Oz.
27323	Gasket—Breather Body.....	1
29658	Breather Assembly.....	4
29667	Point Assembly—Contact.....	2
29670	Magneto Assembly.....	3
	<b>Note: No. 29935</b> Magneto Assembly.....	6
	Used on type Nos. 20089, 20266, 60972.	
	Includes: <b>No. 65915</b> Wire—Ground.....	1
	<b>No. 29984</b> Magneto Assembly.....	6
	Used on type No. 60908.	
	Includes: <b>No. 66155</b> Wire—Ground.....	1
29671	Armature—Magneto .....	2
29674	Cable—Ignition .....	2
29693	Plug—Spark (with Gasket).....	3
29704	Pedal—Starter .....	1
29733	Rod Assembly—Connecting.....	8
29739	Piston Assembly—Standard.....	8
29741	Clutch and Pulley—Starter.....	1
	<b>Note: No. 29853</b> Clutch and Pulley—Starter....	1
	Used on type Nos. 20261, 20262, 20263, 20275, 20277, 20280, 20376, 20404, 60900, 60924, 60939.	
	<b>No. 29885</b> Clutch and Pulley—Starter.....	1
	Used on type Nos. 20251, 20252, 60909, 60935.	
	<b>No. 99349</b> Clutch and Pulley—Starter.....	1
	Used on type Nos. 20015, 20042, 20095, 20097, 20368, 20371, 20388, 20413, 20422, 20436, 20494, 20840, 20959, 20975, 60908, 60929, 60938, 60982, 60988.	
29743	Pulley—Drive, V-Belt—2-3/4" Dia.....	8
	<b>Note: No. 29913</b> Pulley—Drive, V-Belt—1-15/16" Dia.....	8
	Used on type Nos. 20097, 20266, 20276, 60972.	
29746	Cylinder .....	13
	<b>Note: No. 29847</b> Cylinder.....	13
	Used on type Nos. 60915, 60961.	
29767	Rod—Choke—11 1/2" long.....	1
	<b>Note: For other lengths specify:</b>	
	<b>No. 19005</b> Rod—Choke—9 1/2" long	
	<b>No. 29869</b> Rod—Choke—11 1/2" long	
	<b>No. 29876</b> Rod—Choke 15" long	
	<b>No. 29909</b> Rod—Choke—9 1/4" long	

MASTER PART NUMBER	NAME	SHIPPING WEIGHT Lbs. Oz.	MASTER PART NUMBER	NAME	SHIPPING WEIGHT Lbs. Oz.
29778	Piston Assembly—.010" O.S.....	8	61700	Housing—Starter Clutch.....	1
29779	Piston Assembly—.020" O.S.....	8		Note: No. 61781 Housing—Starter Clutch.....	1
29780	Piston Assembly—.030" O.S.....	8		Used on type Nos. 20261, 20262, 20263,	
29786	Sector—Starter .....	14		20275, 20277, 20280, 20376, 20404, 60900,	
29788	Starter Assembly—Foot (Right hand offset).....	3		60924, 60939.	
29796	Body Assembly—Carburetor.....	5		No. 61784 Housing—Starter Clutch.....	1
	Note: No. 29875 Body Assembly—Carburetor...	5		Used on type Nos. 20251, 20252, 60909,	
	Used on type Nos. 60915, 60961.			60935.	
29800	Carburetor Assembly.....	8		No. 61973 Housing—Starter Clutch (Cast	
	Note: No. 29821 Carburetor Assembly.....	8		Iron) .....	1
	(Without Choke Valve)			Used on type Nos. 20015, 20042, 20095,	
	Used on type Nos. 29009, 20015, 20027,			20097, 20358, 20371, 20388, 20413, 20422,	
	20042, 20095, 20097, 20099, 20368, 20376,			20436, 20441, 20457, 20494, 20840, 20959,	
	20388, 20404, 20413, 20414, 20419, 20422,			20975, 60872, 60896, 60908, 60929, 60935,	
	20436, 20448, 20494, 20959, 20974, 20975,			60971, 60982, 60988.	
	60872, 60887, 60888, 60908, 60937, 60938,				
	60939, 60971, 60974, 60980, 60982, 60988.				
	No. 29828 Carburetor Assembly.....	8	61703	Gear—Cam .....	1
	Used on type Nos. 60915, 60961.				8
29801	Valve Assembly—Choke.....	2	61742	Head—Cylinder .....	2
	Note: No. 61738 Valve—Choke.....	1	61755	Elbow—Exhaust .....	8
	Used on type Nos. 60915, 60961.		61756	Ring—Piston, Compression—Standard.....	1
29804	Starter Assembly—Foot (Left hand offset).....	3	61757	Ring—Piston, Oil—Standard.....	1
	Note: No. 29920 Starter Assembly—Foot (Left		61760	Key—Flywheel .....	1
	hand offset)		61768	Ring—Piston, Compression—.010" O.S.....	1
	Used on type No. 60938.		61769	Ring—Piston, Compression—.020" O.S.....	1
	No. 99101 Starter Assembly—Foot.....	3	61770	Ring—Piston, Compression—.030" O.S.....	1
	(L. H. Offset—Extension on Pedal Stop)		61771	Ring—Piston, Oil—.010" O.S.....	1
	Used on type No. 20152.		61772	Ring—Piston, Oil—.020" O.S.....	1
	No. 99247 Starter Assembly—Foot.....	3	61773	Ring—Piston, Oil—.030" O.S.....	1
	(L. H. Offset—Extension on Pedal Stop)		62007	Clamp—Fuel Tank.....	1
	Used on type No. 20286.		62534	Retainer—Valve Spring.....	1
29806	Gasket—Spark Plug.....	1	62536	Cup—Starter Return Spring.....	1
29807	Muffler .....	6	62538	Washer—Clutch Retainer.....	1
	Note: Exhaust tubing not included; furnished by		62560	Blade—Governor .....	2
	equipment Manufacturer.		62577	Washer—Flywheel .....	1
29809	Starter Assembly—Foot (Straight).....	3	62597	Guide—Air (right hand).....	1
29829	Housing—Blower .....	2	62598	Guide—Air (left hand).....	1
29830	Starter Assembly—Foot (Gooseneck).....	3	62599	Wrench—Spark Plug.....	6
	Note: No. 29880 Starter Assembly—Foot		62600	Stop—Starter Pedal.....	6
	(Gooseneck) .....	3		Note: No. 99102 Stop—Starter Pedal.....	6
	Used on type Nos. 20271, 60936.			Used on type No. 20152.	
	No. 99096 Starter Assembly—Foot			No. 99246 Stop—Starter Pedal.....	6
	(Gooseneck) .....	3		Used on type No. 20286.	
	Used on type Nos. 20275, 20277.		62628	Washer—Choke Retainer.....	1
29835	Flywheel—Magneto .....	6	62641	Plate—Speed Adjuster Retainer.....	1
29836	Pedal—Starter (Gooseneck).....	1		Note: Earlier model engines used	
	Note: No. 29879 Pedal—Starter (Gooseneck).....	1		No. 62575 Spring—Friction.....	1
	Used on type Nos. 20271, 60936.		62655	Cover—Magneto Point.....	8
	No. 99082 Pedal—Starter (Gooseneck)....	1		Note: No. 62835 Cover—Magneto Point.....	8
	Used on type Nos. 20275, 20277.			Used on type Nos. 20027, 20042, 20099,	
29861	Condenser .....	2		20413, 20414, 20419, 20494, 20959, 60872,	
29863	Outlet Assembly—Fuel Tank.....	2		60887, 60888, 60937, 60938, 60974, 60980,	
29865	Tank—Fuel .....	1		60988.	
	Note: No. 29843 Tank—Fuel		62693	Pulley—Rope Starter.....	12
	Used on type Nos. 20368, 60915		62702	Washer—Choke Valve.....	1
	No. 29870 Tank—Fuel.....	1	62842	Spacer—Dust Cover.....	1
	Used on type Nos. 20027, 20042, 20099,		62893	Link—Throttle .....	1
	20271, 20413, 20414, 20419, 20494, 20959,		62904	Plate—Base .....	1
	60872, 60887, 60888, 60980, 60988.			Note: Base plate with oil pump used on early	
	No. 29886 Tank—Fuel.....	1		model engines is replaced by No. 62904	
	Used on type No. 60937.			which includes instructions for proper	
29878	Rope—Starter .....	4		installation.	
29881	Pedal—Starter (Right hand offset).....	8	63058	Connector—Fuel Pipe.....	1
	Note: No. 29921 Pedal—Starter (Right Hand			Note: No. 29864 Connector—Fuel Pipe.....	1
	Offset) .....	1		Used on type Nos. 60915, 60961.	
	Used on type No. 60938		63136	Pin—Needle Valve Stop.....	1
29882	Pedal—Starter (Left hand offset).....	8	63770	Ball—Clutch .....	1
38852	Washer—Armature .....	1	63771	Bushing—Starter Pedal & Sector.....	1
			63772	Plug—Oil Drain.....	1
			63774	Rod—Governor Blade.....	1
			63782	Valve—Intake .....	1
			63783	Fitting—Exhaust Elbow.....	2
			63785	Shaft—Cam .....	1

(See Next Page)

Before ordering parts, read instructions top page 11.

MASTER PART NUMBER	NAME	SHIPPING WEIGHT Lbs. Oz.	MASTER PART NUMBER	NAME	SHIPPING WEIGHT Lbs. Oz.
63788	Tappet—Valve	1	90916	Screw—Machine, Rd. Hd.— $\frac{1}{4}$ -20 x $\frac{1}{2}$ "	1
63794	Pinion—Starter	4	90950	Screw—Cap, Hex. Hd.—5/16-24 x $\frac{3}{4}$ "	1
63807	Valve—Exhaust	2	91070	Lockwasher—Shakeproof No. 1208	1
63810	Valve—Needle	1	91208	Nut—Hex.—5/16-24	1
	Note: No. 63844 Valve—Needle	1	91237	Lockwasher— $\frac{1}{4}$ x $\frac{3}{32}$ x $\frac{3}{64}$ "	1
	Used on type Nos. 60915, 60961.		91253	Screw—Machine, Fill. Hd.—6-32 x $\frac{5}{16}$ "	1
63821	Wrench—5/16" Socket Head Screw	1	91324	Washer— $\frac{1}{4}$ " Standard	1
63828	Stud—Point Cover	1	91359	Screw—Machine, Fill. Hd. 10-32 x $\frac{3}{4}$ "	1
63949	Stud—Air Cleaner	1	91398	Screw—Cap, Hex. Hd.— $\frac{1}{4}$ x 28 x $\frac{1}{2}$ "	1
65294	Washer—Fuel Tank Outlet	1		No. 92298 Screw—Cap, Hex. Hd.—5/16-18 x $\frac{1}{2}$ "	
65534	Gasket—Filler Cap	1		Note: No. 90681 Screw—Cap, Hex. Hd.—5/16-18 x $\frac{5}{8}$ "	1
65704	Plunger—Contact Point	1		No. 91397 Nut—Hex.—5/16"-18	1
65787	Gasket—Fuel Pipe Connector	1		Used to mount fuel tank on type Nos. 20368, 60915, 60961.	
65968	Disc—Breather	1			
	Used on engines with inside breather.		91401	Screw—Machine—Fill. Hd.—8-32 x $\frac{1}{4}$ "	1
66432	Washer—Speed Adjuster Retainer	1	91432	Screw—Machine—Fill. Hd.—10-32 x $\frac{7}{8}$ "	1
66856	Casing—Control Wire 47" long	8	91449	Screw—Cylinder Head (long)	1
	Note: If a longer casing is needed specify length in inches; if a shorter casing is needed order No. 66856 and cut to required length.		91541	Screw—Cap, Hex. Hd.—5/16-24 x $\frac{7}{8}$ "	1
66866	Wire—Control 50" long	2	91708	Nut—Flywheel	1
	Note: If a longer wire is needed specify length in inches; if a shorter wire is needed order No. 66866 and cut to required length.		91711	Screw—Cylinder Head (short)	1
67307	Gasket—Magneto Plate—.015" thick	1		Note: No. 91387 Screw—Cylinder Head	1
67316	Spring—Control Wire Return	1		Used on type Nos. 60915, 60961.	
67527	Gasket—Valve Cover	1	91741	Screw—Pedal Return Spring Cup	1
67537	Gasket—Cylinder Head	1	91753	Screw—Machine, Fill. Hd.—8-32 x 1"	1
67547	Gasket—Engine Base	1	91758	Screw—Set, Socket Hd.—5/16-24 x $\frac{1}{2}$ "	1
67597	Gasket—Magneto Plate—.005" thick	1	91833	Stud—Dust Cover	1
67607	Gasket—Magneto Plate—.009" thick	1	91849	Screw—Connecting Rod (Slotted Head)	1
67617	Packing—Needle Valve	1		Note: If screw in connecting rod has hexagon head, order No. 92604.	
67847	Sleeve—Ignition Cable	1	91942	Screw—Connecting Rod, Dipper	1
68122	Plug—Cam Shaft	1		With shoulder under Hexagon Head	
68467	Gasket—Carburetor Mounting	1		Note: If dipper screw has no shoulder under head, order No. 92080.	
68957	Gasket—Air Cleaner Mounting	1	92067	Nut—Wing	1
69221	Cap—Fuel Tank	2	92080	Screw—Connecting Rod Dipper	1
	Note: No. 29860 Cap—Fuel Tank	2	92129	Nut—Hex.— $\frac{1}{4}$ -28	1
	Used on type No. 60915.		92285	Pin—Cotter—No. 18 x $\frac{1}{4}$ "	1
69335	Pipe—Fuel—19" long	2	92287	Screw—Machine, Rd. Hd.—10-32 x $\frac{1}{4}$ "	1
	Note: For other lengths specify:		92290	Lockwasher—No. 10 x $\frac{1}{16}$ x $\frac{3}{64}$ "	1
	No. 29243 Pipe—Fuel—10" long	2	92305	Washer—Control Lever (1/16" Thick)	1
	No. 29411 Pipe—Fuel—13" long	2	92306	Screw—Cap, Hex. Hd.— $\frac{1}{4}$ -28 x $\frac{5}{8}$ "	1
	No. 29544 Pipe—Fuel—27" long	4	92324	Rivet—Tubular— $\frac{1}{8}$ x $\frac{7}{32}$ "	1
	No. 29826 Pipe—Fuel—25 $\frac{1}{2}$ " long	4	92604	Screw—Connecting Rod	1
	No. 29858 Pipe—Fuel—21" long	4		Note: If head of screw in the connecting rod is slotted, order No. 91849.	
	No. 29919 Pipe—Fuel—18" long	3	92634	Screw—Machine, Rd. Hd.—5-40 x $\frac{5}{8}$ "	1
	No. 64409 Pipe—Fuel—23" long	4		Note: No. 91752 Screw—Machine, Fill. Hd.—5-40 x $\frac{5}{16}$ "	
	No. 64419 Pipe—Fuel—9 $\frac{1}{4}$ " long	2		Used on type Nos. 60915, 60961.	
	No. 69358 Pipe—Fuel—30" long	4	99023	Cleaner Assembly—Air	1
	No. 69404 Pipe—Fuel—16" long	3		Note: Replaces No. 29823 Air Cleaner.	
	No. 69502 Pipe—Fuel—9 $\frac{1}{2}$ " long	2	99106	Elbow—Air Cleaner	2
	No. 69827 Pipe—Fuel—10 $\frac{1}{2}$ " long	2	99588	Lever Assembly—Throttle	2
	No. 99095 Pipe—Fuel—20" long	4	99630	Cleaner—Air	1
89307	Valve—Oil Return	1	99632	Tooth Assembly—Spring	1
89340	Bushing—Cylinder and Magneto	2	99874	Adjuster—Speed	1
	Includes: No. 23495 Ring—Oil Retainer		290413	Cap—Oil Filler	4
89966	Muffler Assembly	8	290548	Breather Assembly—Inside	2
	Note: Exhaust tubing not included; furnished by equipment manufacturer.		290568	Lever Assembly—Control	4
90067	Screw—Machine—Rd. Hd. 8-32 x $\frac{5}{16}$ "	1	290584	Base—Control Lever	2
90202	Screw—Machine—Fill. Hd. 10-32 x $\frac{1}{2}$ "	1	290642	Lever—Control (Stamped Steel)	2
90313	Nut—Hex.—8-32	1	290792	Plate—Magneto	3
90355	Nut—Hex.—10-32	1		Note: No. 290869 Plate—Magneto	3
90364	Lockwasher—No. 8 x $\frac{3}{64}$ x $\frac{1}{32}$ "	1		Used on type Nos. 20089, 20266, 60908, 60972.	
90366	Lockwasher—5/16 x $\frac{1}{8}$ x $\frac{1}{16}$ "	1	290918	Lever Assembly—Control	3
90367	Lockwasher—No. 8 x $\frac{5}{64}$ x $\frac{1}{32}$ "	1	290980	Pin Assembly—Piston—Standard	2
90528	Screw—Magneto Mounting	1	290981	Pin Assembly—Piston—.005" O.S.	2
90832	Lockwasher— $\frac{1}{4}$ x $\frac{3}{32}$ x $\frac{5}{64}$ "	1			
90847	Nut—Hex.— $\frac{1}{4}$ -28	1			
	Used on engines with inside breather.				
	Note: No. 91707 Screw—Valve Cover	1			
	Used on engines with outside breather.				

Before ordering parts, read instructions top page 11.

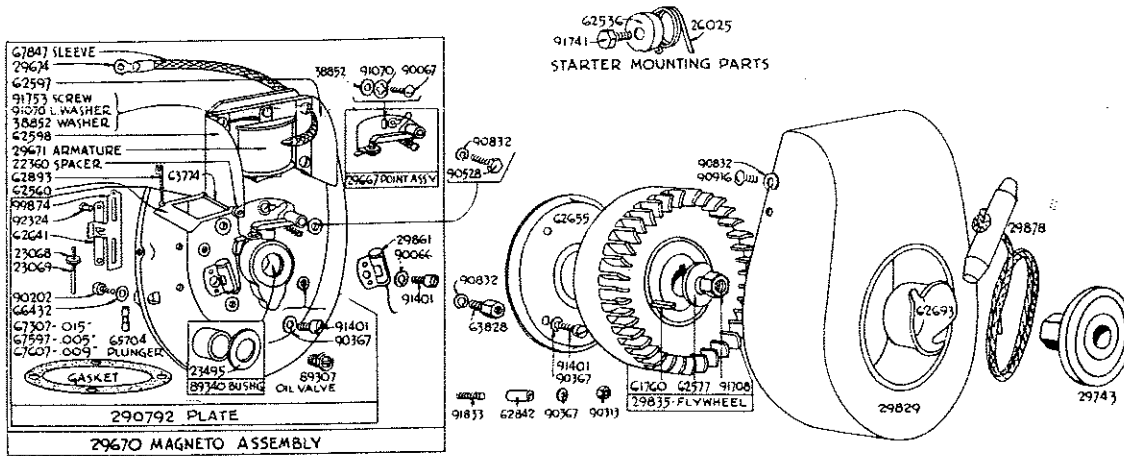
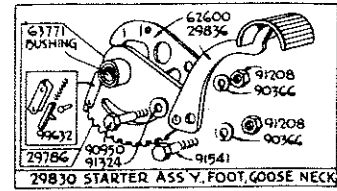
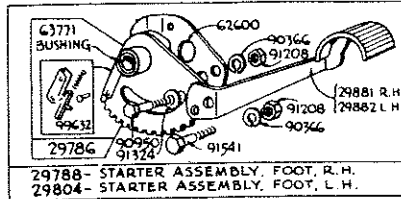
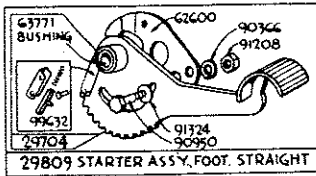

PLATE 1085-47

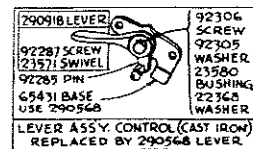
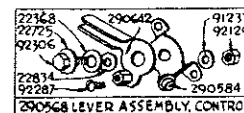
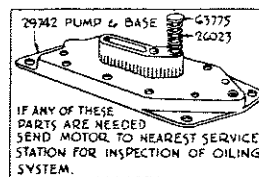
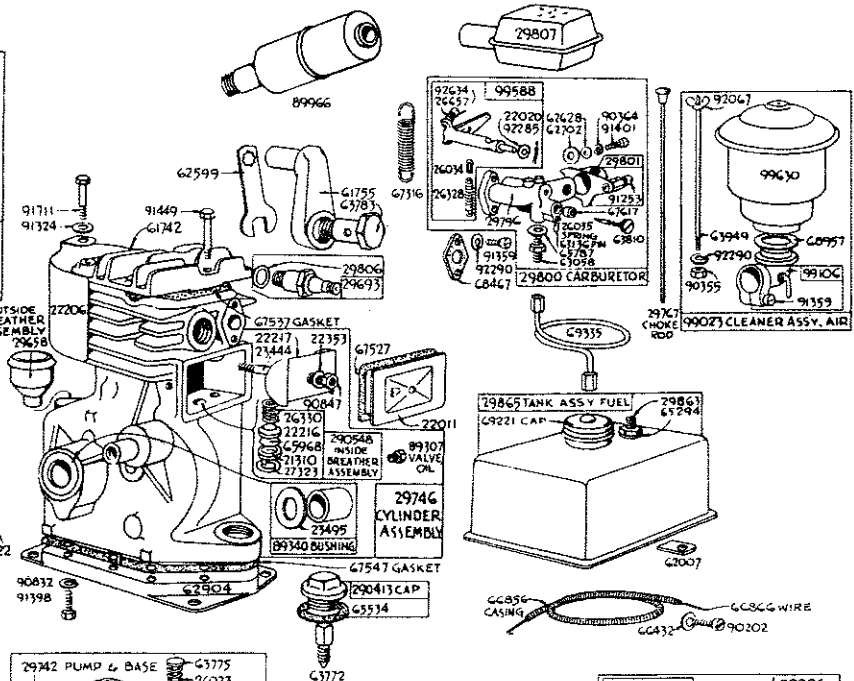
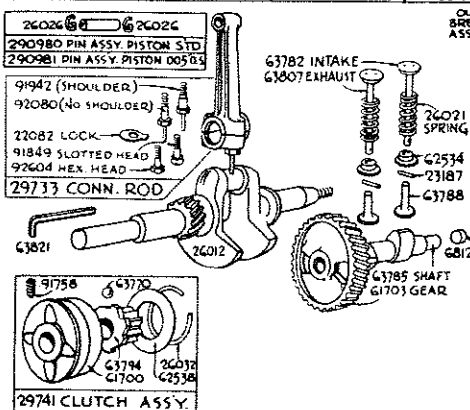
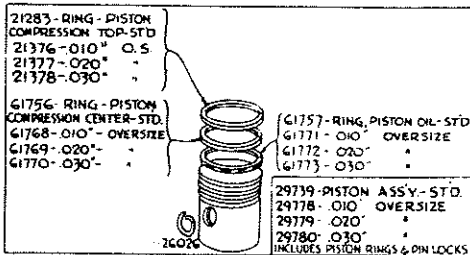

PLATE 1084-47

Assemblies include all parts shown in brackets.



# NATION-WIDE SERVICE ORGANIZATION

To provide prompt and efficient service on Briggs & Stratton motors, Authorized Central Service Distributors and Motor Service Stations are located in the principal cities of the United States and Canada.

Each Authorized Service Organization carries a complete stock of original Briggs & Stratton repair parts. Each is equipped with special factory service tools and factory-trained mechanics, assuring expert repair service on all Briggs & Stratton motors.

All Authorized Service Organizations are instructed by the factory to replace free of charge all parts found to be defective in either material or workmanship, according to the conditions of the Briggs & Stratton Guarantee.

All gratis work done under the guarantee is the responsibility of the Authorized Service Organization until all the material involved and supporting facts are submitted to and approved by the factory.

In a difference of opinion regarding a Service Organization's decision, their terms should be accepted and, either through them or direct, have all materials and supporting facts submitted to the factory for review.

Genuine Briggs & Stratton service will assure continuous motor satisfaction. Our long experience in motor maintenance prompts us to urge that all service work be done by an Authorized Service Organization or at our factory. Mechanics unfamiliar with Briggs & Stratton products, or without proper tools, should not be permitted to make major repairs.

Parts and repair work are F. O. B. Factory or any Authorized Briggs & Stratton Central Service Distributor, or Motor Service Station. The Central Service Distributor nearest you (see list below) will be glad to give you the name of our Motor Service Station in your locality. Space does not permit listing here.

## Authorized Central Service Distributors

STATE	CITY	NAME	LOCATION
Alabama	Birmingham 3	Birmingham Electric Battery Co.	Ave. B. at 23rd St.
Arizona	Phoenix	Motor Supply Co.	402-414 N. Central Ave.
California	Los Angeles 15	Electric Equipment Company	1611 S. Hope St.
California	San Francisco 9	Frank Edwards Co., Automotive Service Div.	382-4 Sixth St.
Colorado	Denver 1	Spitzer Electric Company	43 W. 9th Ave.
Florida	Jacksonville 1	Spencer Electric, Inc.	40 W. Beaver St.
Florida	Miami 32	Electric Equipment Co.	42-58 N. W. 4th St.
Florida	Tampa 1	Spencer Auto Electric, Inc.	607-11 E. Cass St.
Georgia	Atlanta 3	Auto Electric & Magneto Co.	477 Spring St., N. W.
Illinois	Chicago 16	Mid-States Auto Electric Co.	1905 S. Michigan Ave.
Indiana	Indianapolis 4	Gulling Auto Electric Co.	450 N. Capitol Ave.
Iowa	Des Moines 9	Magneto Carburetor & Electric Co., Inc.	1308 Grand Ave.
Kansas	Wichita 2	The E. S. Cowie Electric Co.	230 S. Topeka Ave.
Kentucky	Lexington 34	Kentucky Ignition Co., Incorporated	Rose and Vine Sts.
Kentucky	Louisville 2	Kentucky Ignition Co., Incorporated	737 S. 3rd St.
Louisiana	New Orleans 1	A. C. Suhren Co.	4640 S. Carrollton Ave.
Louisiana	Shreveport 80	Chain Barren & Automotive Supply, Inc.	Marshall at Cotton Sts.
Massachusetts	Newton, Upper Falls	W. J. Connel Co.	210 Needham St.
Michigan	Detroit 1	Auto Electric & Service Corporation	90 Seiden Ave.
Minnesota	Minneapolis 2	Reinhard Brothers Co., Inc.	11 S. Ninth St.
Missouri	Kansas City 8	The E. C. Cowie Electric Co.	1819 Wyandotte St.
Missouri	St. Louis 3	Medart Auto Electric Co., Inc.	3134 Washington Blvd.
Montana	Billings	Original Equipment, Inc.	423 N. Broadway
Nebraska	Lincoln 8	Carl A. Anderson, Inc.	1637 P Street
Nebraska	Omaha 2	Carl A. Anderson, Inc.	16th and Jones St.
New Mexico	Albuquerque	Spitzer Electrical Co of New Mexico	3rd and Mountain Rd.
New York	Buffalo 14	The Battery & Starter Co., Inc.	2505 Main St.
New York	New York 19	The Durham Co., Inc.	606 W. 49th St.
New York	Syracuse 4	F. A. Crossman, Inc.	943 W. Genesee St.
North Carolina	Charlotte 1	Carolina Rim & Wheel Co.	312 N. Graham St.
North Dakota	Fargo	Reinhard Brothers Co., Inc.	301 N. Pacific Ave.
Ohio	Cincinnati 2	Gardner, Inc.	1847 Reading Rd.
Ohio	Cleveland 15	The Electric Power Maintenance Co.	Prospect at East 30th
Ohio	Toledo 2	Electric Power & Maintenance Co.	26-30 Seventeenth St.
Oklahoma	Oklahoma City 2	American Electric Ignition Co.	124 N. W. 8th St.
Oregon	Portland 9	Tracey & Co., Inc.	N. W. 10th and Glisan
Pennsylvania	Philadelphia 30	Auto Equipment & Service Co., Inc.	1522-24 Fairmount Ave.
Pennsylvania	Pittsburgh 24	Pitt Auto Electric Company	5135 Baum Blvd.
South Dakota	Aberdeen	Reinhard Brothers Co., Inc.	317 S. Lincoln St.
South Dakota	Sioux Falls	Reinhard Brothers Co.	225 E. 11th St.
Tennessee	Knoxville 7	R. T. Clapp Company	401-7 N. Broadway
Tennessee	Memphis 4	Automotive Electric Service Co.	982 Linden Ave.
Texas	Amarillo	The E. S. Cowie Electric Co.	700 E. 10th St.
Texas	Dallas 1	Beard & Stone Electric Company, Inc.	3909 Live Oak St.
Texas	El Paso	Motor Supply Co.	308 Chihuahua St.
Texas	Houston 1	Beard & Stone Electric Company, Inc.	Milam at Polk Ave.
Texas	San Antonio 6	S. X. Callahan	425 N. Flores St.
Utah	Salt Lake City 13	Frank Edwards Co., Motor Equipment Div.	551 So. State St.
Virginia	Richmond	Richmond Barnery & Ignition Co.	2912 W. Leigh St.
Washington	Seattle 14	Sunset Electric Co.	300 Westlake North
Washington	Spokane 11	Sunset Electric Co.	N. 703 Division St.
Wisconsin	Milwaukee 2	Wisconsin Magneto Co.	918 N. Broadway
<b>DOMINION OF CANADA</b>			
Manitoba	Winnipeg	Bestie Auto Electric Limited	176 Fort St.
Ontario	Toronto 5	Auto Electric Service Company, Limited	1009 Bay St.

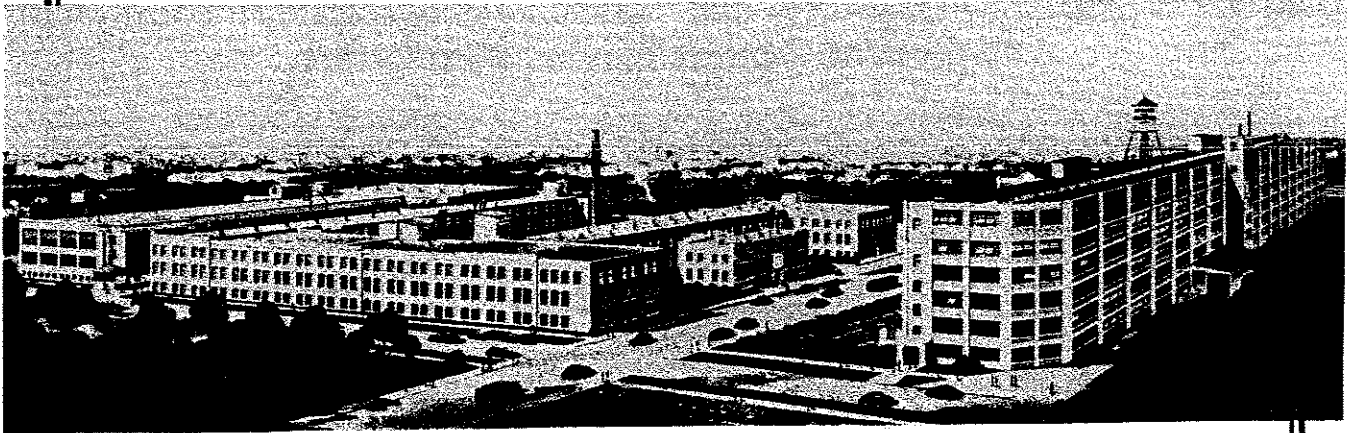

WHERE BRIGGS AND STRATTON MOTORS  
ARE MADE

**T**HESE large and modern factory buildings, located in Milwaukee, Wisconsin, are complete with all modern equipment and machinery for precision construction, economical production, rigid inspection and thorough testing of Briggs & Stratton 4-cycle gasoline motors.

Briggs & Stratton Corp. produces more small 4-cycle air-cooled gasoline motors than any other manufacturer in the world.

**BRIGGS & STRATTON CORP., MILWAUKEE 1, WIS.**