

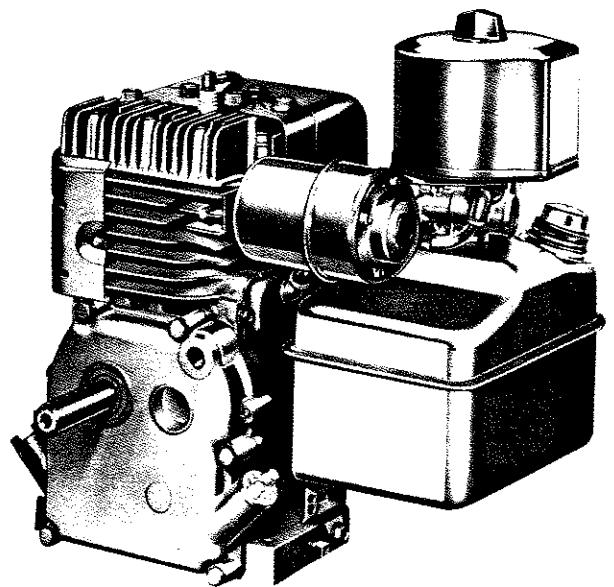

**OPERATING AND MAINTENANCE
INSTRUCTIONS
MODEL SERIES
112200**

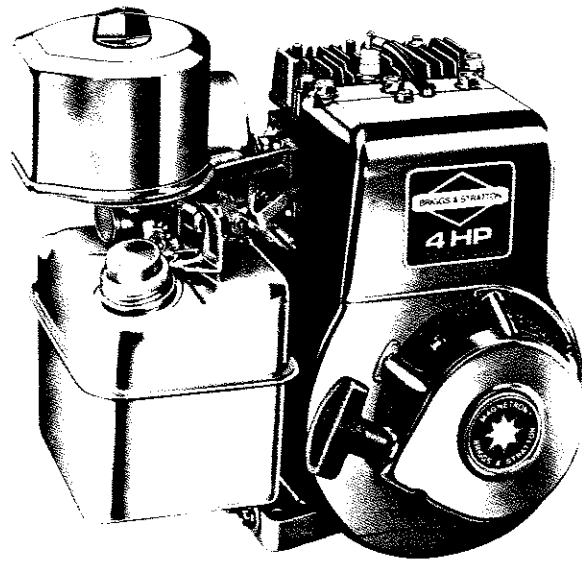

BRIGGS & STRATTON CORP.
Milwaukee, Wisconsin 53201

FORM NO. 271463-6/85

PRINTED IN U.S.A.

IMPORTANT SAFETY INFORMATION AND INSTRUCTIONS FOR ENGINE SELECTION ENGINE INSTALLATION ENGINE OPERATION

In the USA and Canada,
our 24 hour hotline is:

18002333723

Briggs & Stratton Corporation
Milwaukee, Wisconsin 53201

www.briggsandstratton.com

Keep these instructions for future reference.



Before installing and operating this engine read and observe all warnings, cautions and instructions on both sides of this sheet, on the engine, and in the operating & maintenance instructions.

NOTE: This sheet of instructions and safety information is not meant to cover all possible conditions and situations that may occur. Read entire Operating & Maintenance Instructions for this engine AND the instructions for the equipment this engine powers. Failure to follow instructions and safety information could result in serious injury or death.

The safety alert symbol () is used to identify safety information about hazards that can result in personal injury.

A signal word (DANGER, WARNING, or CAUTION) is used with the alert symbol to indicate the likelihood and the potential severity of injury. In addition, a hazard symbol may be used to represent the type of hazard.

 **DANGER** indicates a hazard which, if not avoided, will result in death or serious injury.

 **WARNING** indicates a hazard which, if not avoided, could result in death or serious injury.

 **CAUTION** indicates a hazard which, if not avoided, might result in minor or moderate injury.

CAUTION, when used **without** the alert symbol, indicates a situation that **could result in damage to the engine.**

HAZARD SYMBOLS AND MEANINGS



Fire



Explosion



Moving Parts



Toxic Fumes



Hot Surface



Shock



Kickback

(OVER)

FORM MS-6445-01/03

ENGINE SELECTION

 WARNING

Failure to select the correct engine could result in fire or explosion.

- Some engines are unique and designed for specific applications or types of equipment. If this engine will be used to build new equipment, contact Briggs & Stratton to ensure that the engine is appropriate for the intended use.
Note: For all Go-karts use only a model 136200 series engine, which offers improved safety and performance.
- Replacement engines should be the same model as the original engine, or be the Briggs & Stratton designated replacement engine. Refer to the Operation & Maintenance Instructions for engine identification information.
Note: For all Go-karts use only a model 136200 series engine, which offers improved safety and performance.
- Do not use Briggs & Stratton engines on 3-wheel All-Terrain Vehicles (ATVs), motor bikes, air craft products, or vehicles intended for use in competitive events. Briggs & Stratton does not approve of or authorize such uses.

ENGINE INSTALLATION



- [1] Do not attempt to install this engine if you do not have the appropriate tools and knowledge of small engine installation procedures. Use only Briggs & Stratton parts. Contact your Authorized Service Dealer for assistance.
- [2] Do not modify the engine in any way without Briggs & Stratton factory approval. Any such modification is at the owner's sole risk.
- [3] If the exhaust system on the old engine was supplied by the equipment manufacturer, you must transfer the exhaust system and related components (original muffler and related pipes, brackets, clamps, and shields) to the new engine. All components must be in good condition.
- [4]



 WARNING	Install muffler (and muffler deflector if used) so outlet points away from operator, fuel tank, and equipment, and so muffler heat will not damage or deform engine and components.
	
- [5]



 WARNING	Ensure all fuel lines and fittings are properly assembled and do not leak. Replacement parts must be the same model as the original.
	
- [6]



 WARNING	Ensure all wiring, including safety switches and engine shut-off components are completely installed and functioning properly.
	
- [7] Set engine speed to equipment manufacturer's specification. Refer to equipment manufacturer's manual. Do not tamper with governor springs, or other parts that will increase engine speed above specification.

- [8]







 WARNING	All engine parts, including fuel cap, spark plug, muffler, air cleaner, and covers and guards for drive components (gears, belts, shafts, couplings, etc.) must be in place before attempting to start engine.
	
- [9]

 WARNING	If engine is installed on walk behind lawn mower, all mower components, including cutting blade, must be correctly installed before attempting to start engine.
	
- [10]

 WARNING	When working on the engine or equipment, remove spark plug wire from spark plug. For electric start, remove negative wire from battery.
	
- [11]

 WARNING	Do not check for spark with spark plug removed. Use Briggs & Stratton spark tester #19368.
	

ENGINE OPERATION

	 WARNING
	When adding fuel:
Turn engine off and let engine cool at least 2 minutes before removing gas cap. Fill fuel tank outdoors or in well-ventilated area. Fill tank to about 1 inch below lowest portion of neck to allow for fuel expansion. Keep gasoline away from sparks, open flames, pilot lights, heat, and other ignition sources.	
	 WARNING
	When starting engine:
Remove all external equipment/engine loads. Wait until spilled fuel is evaporated. Start engine outdoors. Pull cord slowly until resistance is felt, then pull rapidly. If engine floods, set choke to OPEN/RUN, place throttle in FAST and crank until engine starts.	
	 WARNING
	When operating equipment:
Do not tip engine or equipment at angle which causes gasoline to spill. Run engine outdoors. Do not run in enclosed area, even if doors or windows are open. Do not choke carburetor to stop engine.	

IN THE INTEREST OF SAFETY

DANGER: DO NOT RUN THE ENGINE IN AN ENCLOSED AREA. Exhaust gases contain carbon monoxide, an odorless and deadly poison.

A FIRE OR EXPLOSION CAN OCCUR RESULTING IN PERSONAL INJURY IF THE FOLLOWING INSTRUCTIONS ARE NOT FOLLOWED:

1. DO NOT FILL GASOLINE TANK while engine is running. Allow engine to cool for two minutes before refueling.
2. Do not operate the engine when an odor of gasoline is present or other explosive conditions exist.
3. If gasoline is spilled, move machine away from the area of the spill and avoid creating any source of ignition until the gasoline has evaporated.
4. DO NOT STORE, SPILL OR USE GASOLINE NEAR AN OPEN FLAME, or devices such as a stove, furnace, water heater which utilize a pilot light, or devices which can create a spark.
5. Refuel outdoors preferably, or only in well ventilated areas.
6. DO NOT OPERATE ENGINE WITHOUT A MUFFLER. Inspect muffler periodically and replace, if necessary.
7. Periodically clean the muffler area to prevent grass, dirt and combustible material from accumulating.
8. DO NOT use this engine on any forest covered, brush covered or grass covered unimproved land unless a spark arrester is attached to the muffler.
9. DO NOT operate the engine if air cleaner or cover directly over the carburetor air intake is removed.
10. DO NOT choke carburetor to stop the engine.
2. A.N.S.I. Standard Safety Specifications for rotary power lawn mowers specify a maximum blade tip speed of 19,000 feet per minute (96.5 meters per second), primarily to reduce the danger from thrown objects.
3. Do not tamper with the engine speed selected by the original equipment manufacturer.
4. DO NOT TOUCH hot mufflers, cylinders or fins as contact may cause burns.
5. Dirt and grass clippings or other debris, in cooling fins or governor parts can affect engine speed. See cleaning instructions in MAINTENANCE section.
6. TO PREVENT HAND OR ARM INJURY, always pull starter cord rapidly to avoid kickback; starting engine with a loose blade or without a blade may cause a severe kickback.
7. ALWAYS KEEP HANDS AND FEET CLEAR OF MOVING OR ROTATING PARTS.
8. TO PREVENT ACCIDENTAL STARTING when servicing the engine or equipment, always remove the spark plug or wire from the spark plug and insert in holding tab shown on page 3.

WHEN WORKING ON EQUIPMENT

DO NOT STRIKE FLYWHEEL with a hard object or metal tool as this may cause flywheel to shatter in operation, causing personal injury or property damage. To remove flywheel, use Briggs & Stratton approved tools only.

IN THE INTEREST OF ENVIRONMENT

A muffler which leaks because of rust or damage can permit an increased exhaust noise level. Therefore, examine the muffler periodically to be sure it is functioning effectively. To purchase a new muffler, see SERVICE AND REPAIR INFORMATION.

WARNING: DO NOT RUN ENGINE AT EXCESSIVE SPEEDS. Operating an engine at excessive speeds increases the danger of personal injury.

1. DO NOT TAMPER WITH GOVERNOR SPRINGS, GOVERNOR LINKS OR OTHER PARTS WHICH MAY INCREASE THE GOVERNED ENGINE SPEED.

WARNING: If this engine is not equipped with a spark arrester and is to be used on any forest covered, brush covered, or grass covered unimproved land, before using on such land a spark arrester must be added to the muffler. The arrester must be maintained in effective working order by the operator. In the State of California the above is required by law (Section 4442 of the California Public Resources Code). Other states may have similar laws. Federal laws apply on federal lands. See your Authorized Briggs & Stratton Service Center for spark arrester muffler options.

SERVICE & REPAIR INFORMATION

If service or repair is needed, contact an Authorized Briggs & Stratton Service Center. To serve you promptly and efficiently, the Service Center will need the model, type and code number on your engine.

Each Authorized Service Center carries a stock of original Briggs & Stratton repair parts and is equipped with special service tools. Trained mechanics assure expert repair service on all Briggs & Stratton engines.

Major engine repairs should not be attempted unless you have the proper tools and a thorough knowledge of internal combustion engine repair procedure.



yellow pages

Your nearest service center is listed in the "Yellow Pages" under "Engines, Gasoline" or "Gasoline Engines". He is one of over 25,000 authorized dealers available to serve you.

This illustrated book includes "Theories of Operation", common specifications and detailed information covering the adjustment, tune-up and repair procedures for 2 through 16 H.P. single cylinder, 4 cycle models. It is available from any Authorized Briggs & Stratton Service Center. Order as Part Number 270962.

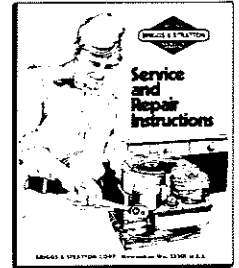

GENERAL INFORMATION

This engine is a single-cylinder L-head, air-cooled type.

MODEL SERIES 112200

Bore..... 2-25/32" (70.64 mm)
 Stroke..... 1-7/8" (47.63 mm)
 Displacement..... 11.39 cu. in. (186.7 cc)
 Horsepower Max..... 4.00 @ 3600 RPM
 Torque (Ft.-Lbs.) Max..... 6.12 @ 2600 RPM

The horsepower rating listed is established in accordance with the Society of Automotive Engineers Test Code-J607. For practical operation, the horsepower loading should not exceed 85% of this rating. Engine power will decrease 3-1/2% for each 1,000 feet (304.8 m) above sea level and 1% for each 10° above 60° F (16° C).

In some areas, local law requires the use of a resistor spark plug so as to suppress ignition signals. If an engine was originally equipped with a resistor spark plug, be sure to use the same type of spark plug for replacement.

TUNE-UP SPECIFICATIONS

Spark Plug Type	Champion,	Autolite
Short Plug	CJ-8	235
Long Plug	J-8C	295
Resistor Short Plug	RCJ-8	245
Resistor Long Plug	RJ-8C	306
Spark Plug Gap	.030" (.76 mm)	
Intake Valve		
Clearance	.005"-.007" (.13-.18 mm)	
Exhaust Valve		
Clearance	.009"-.011" (.23-.28 mm)	

STORAGE INSTRUCTIONS

Engines to be stored over 30 days should be completely drained of fuel to prevent gum deposits forming on essential carburetor parts, fuel filter and tank.

NOTE: The use of a fuel additive, such as STA-BIL®, or an equivalent, will minimize the formation of fuel gum deposits during storage. Such an additive may be added to the gasoline in the fuel tank of the engine, or to the gasoline in a storage container.

- All fuel should be removed from the tank. Run the engine until it stops from lack of fuel.
- While engine is still warm, drain oil from crankcase. Refill with fresh oil.
- Remove spark plug, pour approximately 1/2 ounce (15 cc) of engine oil into cylinder and crank slowly to distribute oil. Replace spark plug.
- Clean dirt and chaff from cylinder, cylinder head fins, blower housing, rotating screen and muffler areas.
- Store in a clean and dry area.

BRIGGS & STRATTON ENGINES ARE MADE UNDER ONE OR MORE OF THE FOLLOWING PATENTS:

2,999,491	3,305,223	3,526,146	3,625,492	3,745,393	3,971,353	4,233,043
3,194,224	3,457,804	3,572,218	3,650,354	3,961,724	4,168,288	4,270,509
3,276,439	3,465,740	3,625,071	3,738,345	3,968,854	4,189,040	

DESIGN
 D-247,177
 OTHER PATENTS PENDING

BEFORE STARTING

READ THE OPERATING INSTRUCTIONS OF THE EQUIPMENT THIS ENGINE POWERS

OIL RECOMMENDATIONS

Note: Engine is shipped WITHOUT oil.

Use a high quality detergent oil classified "For Service SF, SE, SD or SC." Detergent oils keep the engine cleaner and retard the formation of gum and varnish deposits. Nothing should be added to the recommended oil.

RECOMMENDED SAE VISCOSITY GRADES

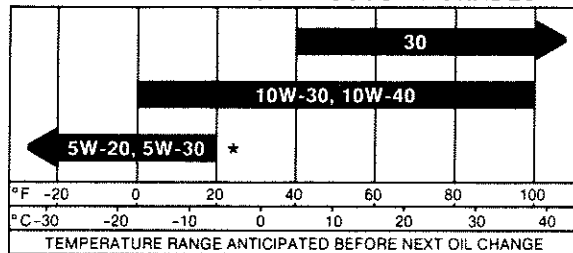

*If not available, a synthetic oil may be used having 5W-20, 5W-30 or 5W-40 viscosity.

TO FILL CRANKCASE WITH OIL

Place engine level. Clean area around oil fill before removing oil fill plug or oil-minder.

OIL FILL PLUG. Remove oil fill plug or (optional) oil-minder. Fill crankcase to point of overflowing. **POUR SLOWLY.** Capacity approximately 1-1/4 pints (0.6 liters). Replace oil fill plug or oil-minder.

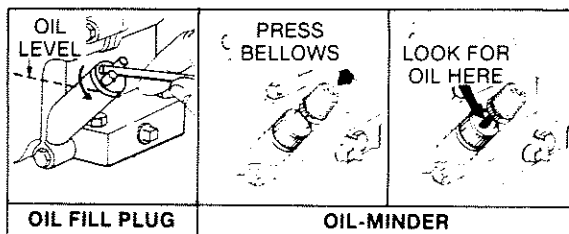

EXTENDED OIL FILL (Optional). Remove cap and dipstick. **FILL TO FULL MARK** on dipstick, **POUR SLOWLY.** Capacity approximately 1-1/4 pints (0.6 liters). When checking oil level, screw dipstick assembly firmly but slowly until cap bottoms on tube. **DO NOT OVERFILL,** or excessive smoking may occur when engine is run. Dipstick assembly must be securely assembled to tube at all times when engine is operating.

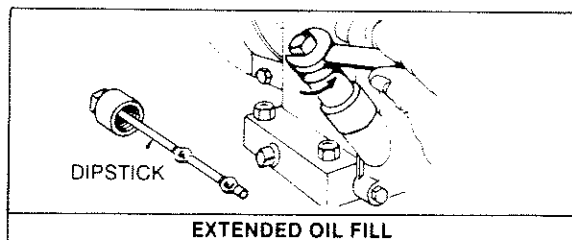

FUEL RECOMMENDATIONS

Our engines will operate satisfactorily on any gasoline intended for automotive use. **DO NOT MIX OIL WITH GASOLINE.**

We recommend the use of clean, fresh, lead-free gasoline. Leaded gasoline may be used if lead-free is not available. A minimum of 77 octane is recommended. The use of lead-free gasoline results in fewer combustion deposits and longer valve life.

DO NOT fill fuel tank to point of overflowing. Provide approximately 1/4" of tank space for fuel expansion.

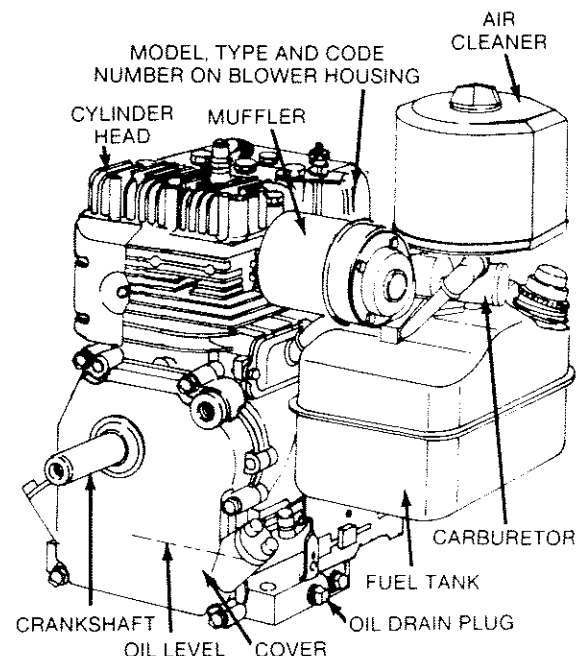
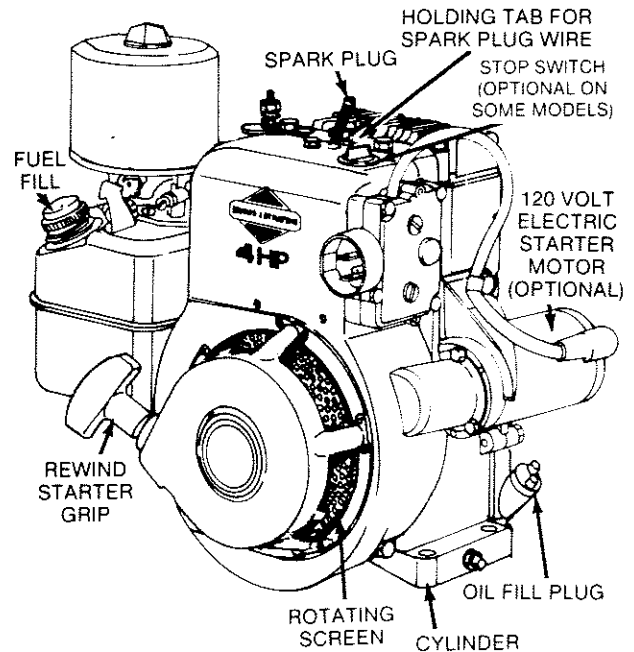

STARTING

Start, store and fuel engine in a level position.
DO NOT use a pressurized starting fluid as severe internal engine damage may occur due to loss of lubrication.

CHOKE ENGINE:

Engine may be equipped with either manual, remote or choke-a-matic controls.

MANUAL CHOKE: Move lever as illustrated.

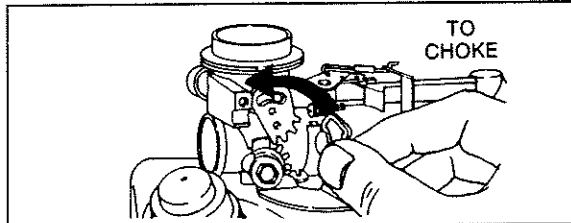

CHOKE-A-MATIC CONTROLS: Move controls as far as possible toward "CHOKE" or "START".

STOP SWITCH: Move STOP switch away from spark plug or to "ON" position as illustrated, if so equipped.

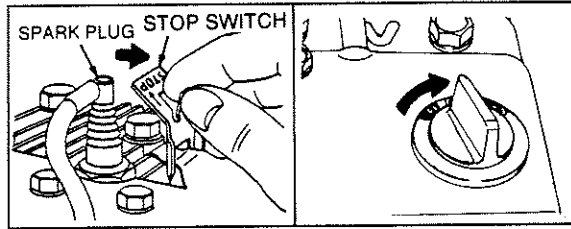

NOTE: A warm engine requires less choking than a cold engine.

NOTE: Engine may not start if controls on powered equipment do not close choke fully. See ADJUSTMENT section.

SPEED CONTROL LEVER: Move speed control lever to "RUN," "FAST" or "START" position if so equipped.

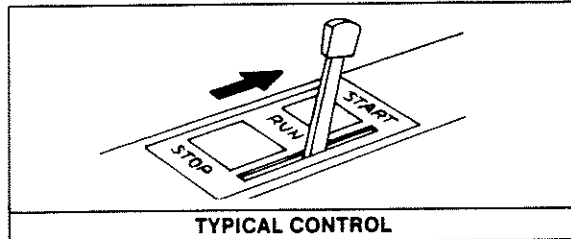

TYPICAL CONTROL

TO START ENGINE

DANGER: ALWAYS KEEP HANDS AND FEET CLEAR OF MOWER BLADE OR OTHER ROTATING MACHINERY.

Rewind Starter. Grasp starter grip as illustrated and pull slowly until starter engages. Then pull cord rapidly to overcome compression, prevent kickback and start engine. Repeat if necessary with choke opened slightly. When engine starts, open choke gradually.

Rope Starter. Wind the starter rope around the pulley in direction shown by arrow. Pull the rope with a quick full arm stroke to overcome compression and prevent kickback. Repeat if necessary with choke opened slightly. When engine starts open choke gradually.

CAUTION: When using rope starter to crank engine, use caution so knotted end of rope does not strike persons standing nearby.

Electric Starter. On engines equipped with electric starting systems, press starter button. Release button as soon as engine starts and gradually open choke.

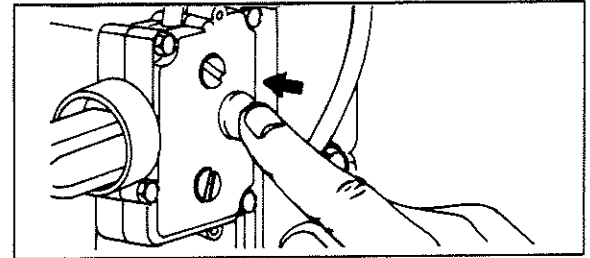
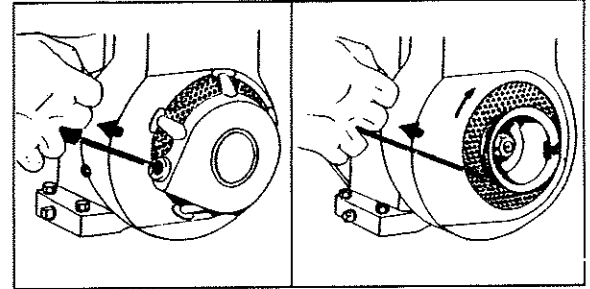

TIPS TO OBTAIN BEST STARTING PERFORMANCE:

- The best starter life is provided by using short starting cycles of several seconds. Prolonged cranking can damage the starter motor if cranked more than 15 seconds per minute.
- Disengage load from engine during start.

CAUTION: The 120 volt electric starter is equipped with a three-prong plug for your safety. The longer prong in this plug is connected to the starter motor housing. When the starter motor is plugged into the three wire cord supplied, and the cord is plugged into a properly grounded receptacle, it will protect the user from shock should the starter motor insulation fail for any reason. If a longer extension cord is used with this starter, it should also have three-prong and three-hole plugs.

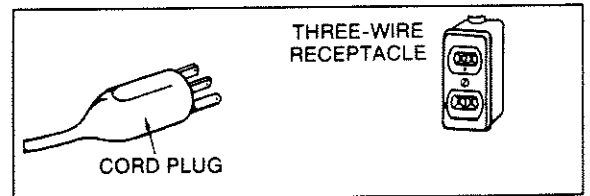

TO STOP ENGINE

Move control to slow, then "STOP" or "OFF" position. Do not choke the carburetor to stop engine.

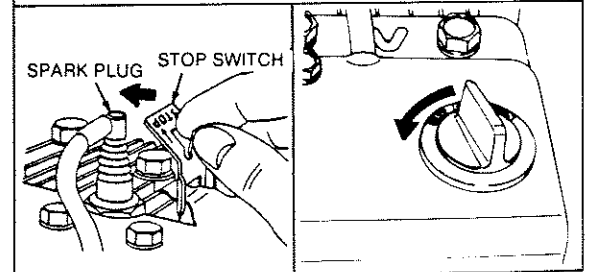
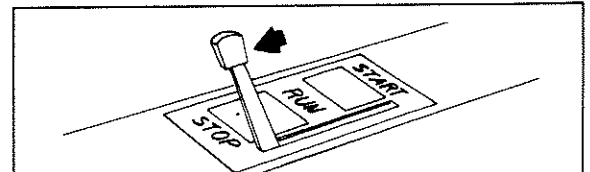

MAINTENANCE

WARNING: TO PREVENT ACCIDENTAL STARTING when servicing the engine or equipment, always remove the spark plug or wire from the spark plug and insert in holding tab shown on page 3.

CHECK OIL LEVEL regularly — after each five hours of operation. BE SURE OIL LEVEL IS MAINTAINED.

CHANGE OIL after first five hours of operation. Thereafter change engine oil every 50 hours of operation, under normal operating conditions. Change engine oil every 25 hours of operation if the engine is operated under heavy load, or in high ambient temperatures. Remove oil drain plug and drain oil while engine is warm. Replace drain plug. Remove oil fill plug, oil-minder, or cap and dipstick and refill with new oil of proper grade. Replace oil fill plug, oil-minder or cap and dipstick.

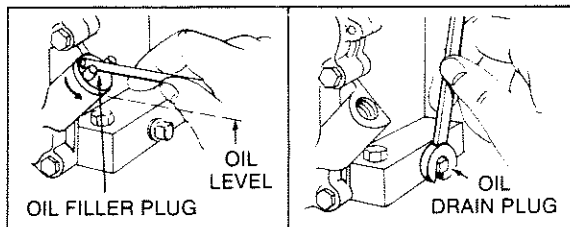

CHANGE OIL (GEAR REDUCTION optional). Remove oil level plug and oil fill plug. Drain oil every 100 hours of operation. To refill, pour 10W-30 oil into filler hole until it runs out level check hole. Replace both plugs. Oil fill plug has a vent hole and must be installed on top of gear case cover.

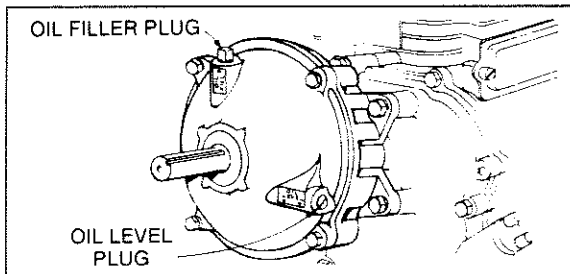

TO SERVICE AIR CLEANERS

CARTRIDGE AIR CLEANER

Clean cartridge at three month intervals or every 25 hours, whichever occurs first.

NOTE: Service more often if necessary.

1. Remove knob and cover.
2. Remove cartridge by pulling it off of the screw.
3. Clean by tapping gently on a flat surface. If very dirty, replace cartridge or clean as follows:
 - a. Wash in a low or non-sudsing detergent and warm water solution. **CAUTION:** Do not use petroleum solvents such as kerosene, to clean cartridge.
 - b. Rinse thoroughly with flowing water from inside out until water is clear.

c. Allow cartridge to stand and air dry thoroughly before using. DO NOT OIL CARTRIDGE. DO NOT USE PRESSURIZED AIR TO CLEAN OR DRY CARTRIDGE.

4. Install cartridge, then cover and screw knob down securely.

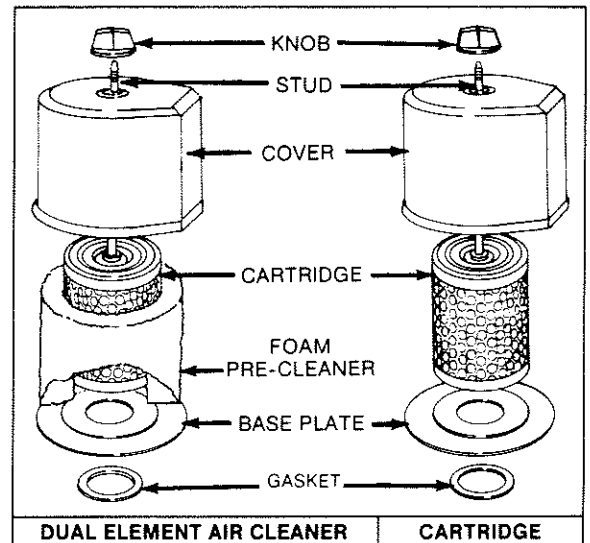

DUAL ELEMENT AIR CLEANER (OPTIONAL ON SOME MODELS)

Clean and re-oil foam pre-cleaner at three month intervals or every 25 hours, whichever occurs first.

NOTE: Service air cleaner more often under dusty conditions.

1. Remove knob and cover.
2. Remove foam pre-cleaner by sliding it off the paper cartridge.
3.
 - a. Wash foam pre-cleaner in kerosene or liquid detergent and water.
 - b. Wrap foam pre-cleaner in cloth and squeeze dry.
 - c. Saturate foam pre-cleaner in engine oil. Squeeze to remove excess oil.
4. Install foam pre-cleaner over paper cartridge. Re-assemble cover and screw down securely.

NOTE: Replace or clean cartridge included with DUAL ELEMENT AIR CLEANER yearly or every 100 hours as described in CARTRIDGE AIR CLEANER. Service more often if necessary.

"OIL FOAM" AIR CLEANER (OPTIONAL)

Clean and re-oil foam element at three month intervals or every 25 hours, whichever occurs first.

NOTE: Service air cleaner more often under dusty conditions.

MAINTENANCE (Cont.)

1. Remove screw.
2. Remove air cleaner carefully to prevent dirt from entering carburetor.
3. Take air cleaner apart and clean.
 - a. WASH foam element in kerosene or liquid detergent and water to remove dirt.
 - b. Wrap foam in cloth and squeeze dry.
 - c. Saturate foam with engine oil. Squeeze to remove excess oil.
4. Reassemble parts and fasten to carburetor securely with screw.

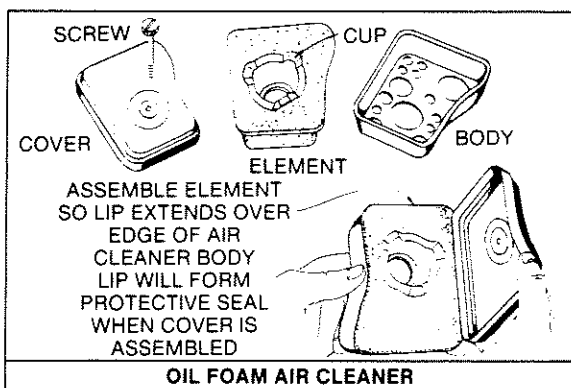

REMOVE COMBUSTION DEPOSITS every 100-300 hours of operation. Remove cylinder head and cylinder head shield. Scrape and wire brush the combustion deposits from cylinder, cylinder head, top of piston and around valves. Use a soft brush to remove deposits. Re-assemble gasket, cylinder head and cylinder head shield. Turn screws down finger tight, with the three longer screws around the exhaust valve, if so equipped. Torque cylinder head screws in a staggered sequence to 140 inch pounds (15.82 Nm).

CLEAN ENGINE — Remove dirt and debris with a cloth or brush. Cleaning with a forceful spray of water is not recommended as water could contaminate the fuel system.

CLEAN COOLING SYSTEM — Grass, chaff or dirt may clog the rotating screen and the air cooling system, especially after prolonged service cutting dry grass. Yearly or every 100 hours, whichever occurs first, remove the blower housing and clean the areas shown to avoid overspeeding, overheating and engine damage. Clean more often if necessary.

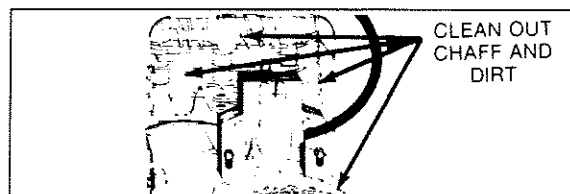

DANGER: Periodically clean muffler area to remove all grass, dirt and combustible debris.

SPARK ARRESTER EQUIPPED MUFFLER — If engine muffler is equipped with spark arrester screen assembly, remove every 50 hours for cleaning and inspection. Replace if damaged.

SPARK PLUG — Clean and reset gap at .030" every 100 hours of operation.

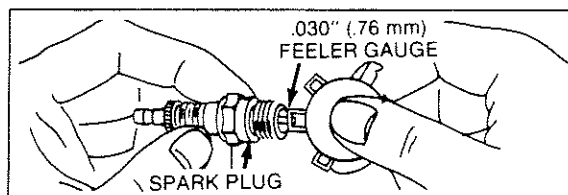

NOTE: Do not blast clean spark plug. Spark plug should be cleaned by scraping or wire brushing and washing with a commercial solvent.

CAUTION: Sparking can occur if wire terminal does not fit firmly on spark plug, or if stop switch vibrates against spark plug. Reform terminal or repair switch if necessary.

ADJUSTMENTS

CARBURETOR ADJUSTMENTS

Minor carburetor adjustment may be required to compensate for differences in fuel, temperature, altitude or load.

NOTE: The air cleaner must be assembled to carburetor when running engine.

TO ADJUST CARBURETOR — Gently turn valve clockwise until it just closes. Valve may be damaged by turning it in too far.

Now open needle valve 1-1/2 turns counterclockwise. This initial adjustment will permit the engine to be started and warmed up (approximately 5 minutes) prior to final adjustment.

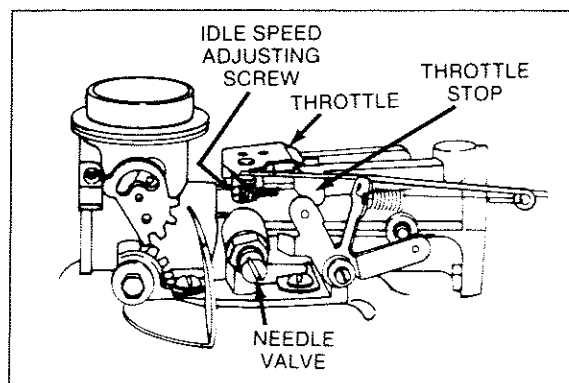

ADJUSTMENTS (Cont.)

FINAL ADJUSTMENT

Place speed control lever in "FAST" position. Turn needle valve in until engine slows (clockwise - lean mixture). Then turn it out past smooth operating point until engine runs unevenly (rich mixture). Now turn needle valve to the midpoint between rich and lean so the engine runs smoothly. Next, adjust idle RPM. Rotate throttle counterclockwise and hold against stop while adjusting idle speed adjusting screw to obtain 1750 RPM. Release throttle — engine should accelerate without hesitation or sputtering. If engine does not accelerate properly, the carburetor should be re-adjusted, usually to a slightly richer mixture.

CONTROL ADJUSTMENTS

The speed control must be properly adjusted to stop, start and operate the engine at maximum speed.

TO CHECK OPERATION OF CHOKE CONTROLS:

Move speed control lever to "choke" position. The carburetor choke should be closed.

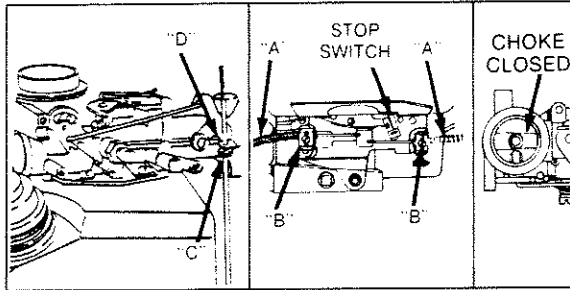

To Adjust:

Place speed control lever on equipment in "FAST" (high speed) position. Loosen control casing clamp screw (B) on control plate. Move control casing (A) and wire forward or backward until washer (C) just touches the choke operating bell crank (D). Tighten casing clamp screw (B) on control plate. Recheck operation of controls after adjustment. Move control lever to "STOP" position. Lever must make good contact with stop switch if so equipped. Replace air cleaner.

SPEED CONTROL ADJUSTMENT

The acceptable operating speed range is 1800 to 3600 RPM. Idle speed is 1750 RPM. The manufacturer of the equipment on which the engine is used, specifies the top governed no load speed at which the engine may be operated. DO NOT EXCEED this speed.

Standard Control — Fixed Speed

The governor speed lever has been adjusted to permit the top no load speed specified by the equipment manufacturer. DO NOT bend governor speed lever.

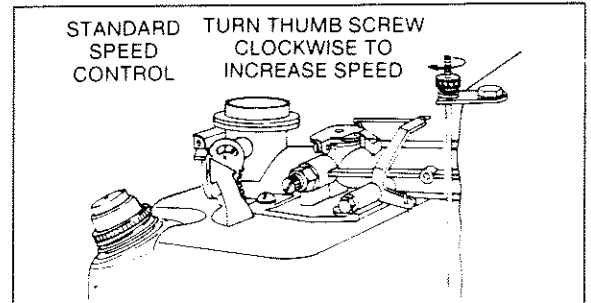

Manual Friction Control

To increase or decrease engine speed, move control rod as shown below.

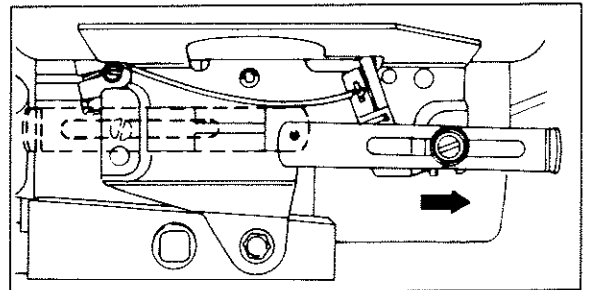

Speed Control

Controls on powered equipment should move governor speed lever in a direction that will elongate governor spring to increase speed.

